

04



Building with Timber in Bushfire-prone Areas

BCA Compliant Design and Construction Guide



Technical Design Guides

A growing suite of information, technical and training resources created to support the use of wood in the design and construction of buildings.

Topics include:

- #01 Timber-framed Construction for Townhouse Buildings Class 1a
- #02 Timber-framed Construction for Multi-residential Buildings Class 2, 3 & 9c
- #03 Timber-framed Construction for Commercial Buildings Class 5, 6, 9a & 9b
- #04 Building with Timber in Bushfire-prone Areas
- #05 Timber service life design – Design Guide for Durability
- #06 Timber-framed Construction – Sacrificial Timber Construction Joint
- #07 Plywood Box Beam Construction for Detached Housing
- #08 Stairs, Balustrades and Handrails Class 1 Buildings – Construction
- #09 Timber Flooring – Design Guide for Installation
- #10 Timber Windows and Doors
- #11 Noise Transport Corridor Design Guide
- #12 Impact and Assessment of Moisture-affected, Timber-framed Construction
- #13 Finishing Timber Externally
- #14 Timber in Internal Design
- #15 Building with Timber for Thermal Performance
- #16 Massive Timber Construction Systems Cross-laminated Timber (CLT)

Other WoodSolutions Publications

R-Values for Timber-framed Building Elements

To view all current titles or for more information visit woodsolutions.com.au



WoodSolutions is an industry initiative designed to provide independent, non-proprietary information about timber and wood products to professionals and companies involved in building design and construction.

WoodSolutions is resourced by Forest and Wood Products Australia (FWPA). It is a collaborative effort between FWPA members and levy payers, supported by industry peak bodies and technical associations.

This work is supported by funding provided to FWPA by the Commonwealth Government.

ISBN 978-1-920883-81-2

Researcher:

Boris Iskra

Writer: Rilke Muir

TPC Solutions Pty Ltd

Level 2, 2 Market Street

Melbourne VIC 3000

First produced: March 2010

Revised: November 2011, May 2012

© 2012 Forest and Wood Products Australia Limited.

All rights reserved.

These materials are published under the brand WoodSolutions by FWPA.

IMPORTANT NOTICE

Whilst all care has been taken to ensure the accuracy of the information contained in this publication, Forest and Wood Products Australia Limited and WoodSolutions Australia and all persons associated with them (FWPA) as well as any other contributors make no representations or give any warranty regarding the use, suitability, validity, accuracy, completeness, currency or reliability of the information, including any opinion or advice, contained in this publication. To the maximum extent permitted by law, FWPA disclaims all warranties of any kind, whether express or implied, including but not limited to any warranty that the information is up-to-date, complete, true, legally compliant, accurate, non-misleading or suitable.

To the maximum extent permitted by law, FWPA excludes all liability in contract, tort (including negligence), or otherwise for any injury, loss or damage whatsoever (whether direct, indirect, special or consequential) arising out of or in connection with use or reliance on this publication (and any information, opinions or advice therein) and whether caused by any errors, defects, omissions or misrepresentations in this publication. Individual requirements may vary from those discussed in this publication and you are advised to check with State authorities to ensure building compliance as well as make your own professional assessment of the relevant applicable laws and Standards.

The work is copyright and protected under the terms of the Copyright Act 1968 (Cwth). All material may be reproduced in whole or in part, provided that it is not sold or used for commercial benefit and its source (Forest & Wood Products Australia Limited) is acknowledged and the above disclaimer is included. Reproduction or copying for other purposes, which is strictly reserved only for the owner or licensee of copyright under the Copyright Act, is prohibited without the prior written consent of FWPA.

WoodSolutions Australia is a registered business division of Forest and Wood Products Australia Limited.

Table of Contents

Introduction	4
1. Standard Maintains the Use of Timber Frames and Construction Materials	5
2. Understanding Key Requirements	6
3. Understanding the Bushfire Attack Level	7
4. What Timbers Can We Use?	8
5. Building with Timber – Construction Requirements for Bushfire Attack Levels	9
BAL-LOW	9
BAL-12.5.10
BAL-19.15
BAL-29.19
BAL-40.23
BAL-FZ28
6. Bushfire Flame Zone Resistant Sheet Metal Roofs	34
Appendix A. NSW Variations to Building Variations	39
Appendix B. South Australian Variations to Building Variations	43

Introduction

The intention of AS 3959–2009 is to:

- improve the ability of a building to withstand attack from bushfire;
- provide the building with a level of protection while the front passes; and
- give occupants a level of protection while a fire front passes.

However, because fire is naturally unpredictable and extreme weather conditions can present more difficulties, these measures cannot guarantee a building will survive.

* Reference should also be made to relevant State and Territory Planning requirements (e.g. Planning for Bush Fire Protection Guidelines (Edition 2) published by the Western Australian Planning Commission and the Fire and Emergency Services Authority; Planning for Bush Fire Protection 2006 published by the NSW Rural Fire Service; South Australian Development Plans issued by the Department of Planning and Local Government) that may modify specific Bushfire Attack Level assessments as well as construction requirements.

Designing to ‘build out’ bushfires requires minimising the risk of ember, radiant heat and even flame damage. With appropriate design decisions you can create an attractive timber home, using sustainably sourced timber both inside and out.

Bushfires are becoming more frequent around the world and, as a consequence of global warming and changes in weather patterns, they are increasingly severe. The destruction from uncontrolled fires, some lasting for months, disrupts families, businesses and communities. The question of how and where to build or rebuild to minimise risk is being asked in many countries.

In Australia, the updated *Standard AS 3959–2009 Construction of buildings in bushfire-prone areas* has the benefit of many years of scientific development and provides an extensive guide to building homes to minimise risk for different levels of bushfire vulnerability.

This guide has been written to help architects, designers, builders and owners to understand the Standard and what is required for each of the Bushfire Attack Level (BAL) areas. It focuses on traditional building methods using timber.

Where applicable, the contents explain alternative ways of compliance. For instance, there are several ways to comply with the Standard with respect to windows. One is the permanent fitting of bushfire shutters or screens. Another is to lift windows higher than 400 mm off the nearest external ‘horizontal’ surface – this saves on the extra glazing and joinery requirements needed to protect a lower window.

Building safely means building bushfires out – it does not necessarily mean abandoning timber. In fact, the first roof system tested to comply with the most demanding BAL – FZ (Flame Zone) requirements uses seasoned plywood as a roof membrane to provide additional ‘insulation’ and to support other components. This roof system has now been incorporated into AS 3959 as a deemed-to-satisfy solution.

Updates

New information about building with timber in bushfire-prone areas will be available at www.woodsolutions.com.au.

Related Publications

‘Timber Housing in Bushfire-prone Areas’: An overview of the issues involved in designing and building with timber while complying with the Standard.

Information and updates will be available at www.woodsolutions.com.au

Adoption of AS 3959-2009 by the various Australian States and Territories.

AS3959–2009 Construction of buildings in bushfire-prone areas was formally referenced in the Building Code of Australia 2010 (BCA 2010) on 1 May 2010. Although referenced, the BCA does allow State variations or deletions of some of its provisions. The following summarises the adoption of AS 3959–2009 by the various Australian States and Territories. (*also see side-bar note)

Queensland, Northern Territory, Australian Capital Territory

Adopted without change.

New South Wales

Refer to Appendix A (this Guide) regarding the modified BAL construction requirements as detailed in *Planning for Bush Fire Protection – Addendum: Appendix 3 - NSW Rural Fire Service*, e.g. unenclosed raised floors (less than 400 mm above finished ground level) and unenclosed decks – apply BAL–29 construction requirements for BAL–12.5 and BAL–19.

Tasmania

Plus specific vehicular access and water supply requirements as detailed in the BCA.

South Australia

Refer to Appendix B (this Guide) for modified BAL construction requirements as detailed in the BCA.

Victoria

Refer *Building Amendment (Bushfire Construction) Regulations 2011* – minimum construction standard of BAL–12.5 in designated bushfire-prone areas.

Western Australia

Refer to modified requirements as detailed in *Planning for Bush Fire Protection Guidelines*.

1

Visit www.woodsolutions.com.au for the most up-to-date data sheets and information on building out bushfires.

Standard Maintains the Use of Timber Frames and Construction Materials

This Guide shows how you can design and build with timber and meet the requirements of the Australian Standard AS 3959–2009 Construction of buildings in bushfire-prone areas to build out bushfires.

Written for those designing or building new homes requiring bushfire protection, this Guide will help you continue many traditional building practices and learn new ones needed to meet the requirements of AS 3959–2009 in each of the six Bushfire Attack Levels (BAL).

The emphasis is on keeping out embers and protecting against radiant heat and even flame contact. As part of revising the Standard, scientific testing confirmed that these are the key aspects of building out bushfires.

Most importantly, AS 3959–2009 makes no additional requirement for internal framing. Wherever you are building, you can still use cost-effective and sustainable timber framing. As the Standard does not limit you to a concrete slab, you can still benefit from the advantages of building off the ground, which include the embodied carbon of the material and the cost advantages in construction on sloping sites.

This Guide clarifies how, where and what types of timber can be used in home construction in keeping with the Standard. Normal building practices and materials apply for the lowest bushfire-attack level (BAL–LOW) – typically applied to homes in suburbs and built-up areas. The other five levels require increasingly stringent protection of the building envelope. These are outlined in this Guide and will be updated by data sheets as new complying building and materials systems are tested and approved.

AS 3959–2009 makes no demands on framing material, allows suspended timber-floor construction and includes options for weatherboard and other lightweight external cladding materials. These can even be used at the highest bushfire attack levels – with appropriate building techniques. For instance, the moisture-resistant firegrade plasterboard and timber system (see pages 32 & 33) which has been tested to perform beyond the Standard's requirements.

The Standard also specifies which timbers can be used and in what ways. The Standard identifies seven bushfire-resisting timbers and two categories for other timbers suitable for a range of applications across the bushfire attack levels (see page 8). Suitable timbers include many hardwoods already used, for instance, for decking and window frames. In the lower BALs the Standard provides for the use of timber in combination with other products.

Use this guide in conjunction with the Standard for more complex details. Our simple approach and practical instructions will help you establish what is required when building or specifying to comply with AS 3959–2009. To this end, we have also included some design tips – based on the science behind the Standard and research from previous bushfire experiences.

2

Before investing in bushfire shutters, homeowners should ensure that they do actually comply for their site's Bushfire Attack Level and get it in writing. They should also check that the bushfire shutters or screens can be closed and secured quickly and safely by everyone in the family.

Understanding Key Requirements

What is an external horizontal surface?

A number of the Bushfire Attack Levels (BALs) specify extra requirements for building components, such as some cladding, doors and windows, that are 400 mm or closer to "an external surface which may collect smouldering embers or burning debris". Such surfaces include the ground, a deck, balcony, carport roof, awning, etc, having an angle less than 18° to the horizontal and extending more than 110 mm in width from the door or window. (See Appendix D of *AS 3959-2009 Construction of buildings in bushfire-prone areas*).

Complying shutters

AS 3959-2009 Clause 3.7 specifies that shutters must be non-removable (but operable) and, when closed, there should be no gap more than 3 mm between the shutter and wall, the sill or the head. Check the shutters comply with the Standard's construction requirements or have been tested for the particular BAL.

Complying screens for windows and doors

Where fitted, screens for windows and doors need to be made of materials specified for the relevant BAL and have a mesh (or perforated sheet) with a maximum aperture of 2 mm. Gaps between the perimeter of screen assembly and the building element to which it is fitted should not exceed 3 mm. The frame supporting the mesh or perforated sheet needs to be made from materials specified for the relevant BAL.

Building Materials

The Standard AS 3959-2009 makes reference to requirements in two parts of AS 1530 to establish the suitability of certain materials or building systems at higher bushfire attack levels.

AS 1530.8-2007 Building Materials in Bushfire-prone Areas

For bushfire-prone areas, AS 1530 offers a verification method to an approved standard for the testing and certification of building systems. AS 3959-2009 references Part 8.1 and 8.2.

The test methods for building elements of construction exposed to simulated bushfire attack are:

- AS1530 Part 8.1 – Radiant heat and small flaming sources
- AS1530 Part 8.2 – Large flaming sources.

Building designers, those ordering building materials and building surveyors need to ensure that they use test reports, issued by Registered Testing Authorities, as quantifiable evidence of suitability for their performance-based bushfire designs and construction when required by AS 3959-2009.

AS 1530.4-2005 Fire Resistance Level (FRL)

The Building Code of Australia (BCA) defines a Fire Resistance Level (FRL) as the grading when under fire attack, in minutes, for three criteria: structural adequacy, integrity and insulation.

- Structural adequacy is the ability of a structure to maintain its stability and load-bearing capacity
- Integrity is the ability of a structure to resist the passage of flames and hot gases
- Insulation is the ability of a structure to maintain a temperature below specified limits on the surface *not exposed* to fire.

For example, a FRL requirement for glazing FRL -/30/- means there is a requirement that the glass can resist the passage of flame and hot gases for at least 30 minutes.

The relevant standard is *AS 1530.4-2005 Methods for fire tests on building materials, components and structures – Fire-resistance tests of elements of construction*.

What is decking?

The term, as used in the Standard, includes decking, stair treads and the trafficable surfaces of ramps and landings. Depending on the requirements of the relevant BAL, materials include treated and untreated timber decking boards, sheet products, concrete and ceramic tiles.

Vents and Weepholes

When located in an external wall of a sub-floor space are to be screened with a mesh with a maximum aperture of 2mm and made up of corrosion-resistant steel or bronze in BAL-FZ locations.

3

'Slope' refers to the slope under the classified vegetation in relation to the building – not the slope between the vegetation and the building.

Understanding the Bushfire Attack Level

Assessing the Bushfire Attack Level (BAL) of the home site is the first step towards building. Slope, surrounding vegetation type and proximity are part of the assessment.

This requirement applies to any new home construction – on new sites, infill and rebuilding and some renovations, repairs and additions in areas subject to the Standard. Local councils and shires may have other matters to be considered. Check before preparing planning applications.

BAL, as defined in AS 3959–2009, considers the type of the surrounding vegetation, the distance of the vegetation from the site and the effective slope of the land under the classified vegetation. Once a site has been assessed for its BAL, plans, building methods and materials need to take the requirements of that BAL into account.

BAL-LOW Standard construction materials and methods, including timber framing and cladding materials can be used. These sites have no special requirements as there is such a low risk of bushfire attack.

Building wisely to the Standard includes using specific timbers for doors and frames, windows, cladding and decks.

BAL-12.5 Some possibility of ember attack has been identified from looking at the closeness of vegetation, the site itself and local conditions with construction elements expected to be exposed to a heat flux not greater than 12.5 kilowatts per square metre (kW/m²).

BAL-19 Sites identified as having an increasing level of predicted ember attack and burning debris ignited by wind-borne embers together with an increasing heat flux, but not greater than 19 kW/m².

BAL-29 Increasing level of chance of ember attack and burning debris ignited by wind-borne embers, together with an increasing heat flux but not greater than 29 kW/m².

Additionally, at these next BALs, fire resistant lining materials, thicker or treated glass, special shutters and building systems increase protection.

BAL-40 Further possibility of ember attack and burning debris ignited by wind-borne embers; together with an increasing heat flux but not greater than 40 kW/m² and an increased likelihood of exposure to bushfire flames.

BAL-FZ Very bushfire-prone, probably in a picturesque bushland setting, a home with this BAL has a predicted direct exposure risk to flames from a fire front, ember attack and a heat flux greater than 40 kW/m².

Reduce the potential for bushfire attack and damage by following the Standard's guidelines for building systems and materials and special timber choices. Following the Standard, ensuring commonsense maintenance, as well as complying with Wildfire Management Overlays (WMO) and fire authority rules and instructions, are all important.

This information is based on Table 3.1 AS 3958–2009.

4

What Timbers Can We Use?

There is no restriction on what structural timber products are used for house framing. Use engineered, softwood or hardwood products as usual.

For internal joinery applications again there are no limitations on materials. Continue with normal use of timber products for doors, wall lining, ceiling linings, floorboards, staircases, etc.

In a range of external situations, appropriately treated timber products and many high density Australian hardwoods are suitable for use in meeting the requirements of higher Bushfire Attack Levels (BAL).

For external applications the material used depends on the designated BAL. As well as the timbers indicated in the following tables, suitably treated timbers are often an option. Your manufacturer or supplier will be able to advise you in regard to the compliance of particular treated timber products and their external application for each BAL.

Australia has a number of high density timbers that provide an inherent natural bushfire resistance. Seven of these are defined by AS 3959–2009 as bushfire-resisting timbers (BRTs). They are solid, dense hardwoods that performed well in extensive fire testing.

Both fire-retardant (FR) treated timbers and specific species can be used in many external applications. These are specified in AS 3959–2009 and summarised in this publication. Lists of timber species with specified densities are given in Appendix E of AS 3959–2009 *Construction of buildings in bushfire-prone areas*. The most common construction timbers from these lists are:

Bushfire – resisting timbers* (BRTs)

Blackbutt	Kwila (Merbau)	Red Ironbark	River Red Gum	Silvertop Ash
Spotted Gum	Turpentine.			

Timber* species from E1: density 750 kg/m³ or greater include:

All BRTs (above) plus:

Brownbarrel	Grey Box	Grey Gum	Grey Ironbark
Jarrah	Manna Gum	Messmate	Mountain Grey Gum
Stringybark/s	Sugar Gum	Sydney Blue Gum	

Timber* species from E2: density 650 kg/m³ or greater include:

All species from E1 (above, including BRTs), also:

Alpine Ash	Slash Pine	Mountain Ash (Victorian Ash)	Shining Gum	Cypress
------------	------------	------------------------------	-------------	---------

*in solid, laminated or reconstituted form.

Timber log walls (gauge planed, species density of 680kg/m³ or greater at 12% moisture content) can also be used with a minimum nominal overall thickness of 70mm (at the interface of two logs) and comply up to BAL–19.

Homeowners need to understand what is being used and why. Some examples of external timber applications:

- Bushfire shutters made from bushfire-resisting timber comply up to BAL–29.
- Window frames made from E2 timber such as Victorian (Mountain/Alpine) Ash comply up to BAL–19 (at any height within a wall).
- Treated pine external wall cladding that is 400 mm or more above the ground complies up to BAL–19. Such cladding can also be installed as part of a system which complies with BAL–FZ requirements that can be used at lower BALs as well (see pages 32 and 33).

To ensure a ready supply of suitable species for your requirements it is a good idea to check with your usual or local timber supplier before specifying timber types.

5

Building with Timber – Construction Requirements for Bushfire Attack Levels

A Bushfire Attack Level (BAL), as defined in AS 3959–2009, considers the type of the surrounding vegetation, the distance of the vegetation from the site and the effective slope of the land under the classified vegetation.

BAL-LOW

Most metropolitan and suburban blocks are defined as BAL-LOW. These sites have no special requirements as there is a very low risk of bushfire attack.

Build as usual once BAL-LOW is confirmed by the site's local government, building surveyor or planning authority.

All traditional timber framing products and systems can be used, along with the usual timber species and treated pine for decks, balustrades, handrails, finials, pergolas, etc.

We recommend building with a timber sub-floor, rather than a concrete slab, for less environmental damage to the site and all the convenience and comfort of building off the ground.

The production of wood products uses less energy (usually sourced from finite fossil fuels) compared with some other building materials.

A timber frame also reduces your carbon footprint. Growing trees absorb carbon dioxide from the atmosphere and store the carbon so efficiently that about half the dry weight of a tree is carbon. This carbon remains locked up in the wood even when we use it for building products or furniture.

Individual state and territory requirements may exist for this Bushfire Attack Level. Please refer to Adoption AS 3959-2009 by the various Australian states and territories (page 4) for guidance.

Bushfire provisions apply to:

- Class 1 buildings
- Class 2 & 3 buildings
- Associated Class 10a buildings

The Building Code of Australia Performance Requirement P2.3.4 (with similar wording for Class 2 and 3 buildings) says: "Bushfire areas: A Class 1 building and any associated Class 10a buildings must be designed and constructed to reduce the risk of ignition from a bushfire while the fire front passes."

BAL-12.5

At BAL-12.5, some possibility of ember attack has been identified, from looking at the closeness of vegetation, the site itself and local conditions. The '12.5' means that external construction elements are not expected to be exposed to a heat flux greater than 12.5 kilowatts per square metre (kW/m²).

For a bushfire resisting building at this BAL, the Standard allows roofs to be fully sarked as a simple means of compliance. There are requirements for windows – the most vulnerable part of the building envelope. The easiest window solution is simply to lift the bottom of the window to above 400mm from any adjacent 'horizontal' surface – such as decking, porch or garden, roof section or balcony – then extra requirements are minimal.

All traditional timber framing products and systems can be used, along with the usual timber species and treated pine for decks (bearers and joists), balustrades, handrails, finials, pergolas etc.

It should also be noted that you can still build with a timber sub-floor, rather than a concrete slab, for less damage to the site, a smaller carbon footprint and all the convenience and comfort of building off the ground. *Note: When building with an unenclosed sub-floor, storage of combustible materials in the sub-floor space should be avoided.

The simplest solution for decking at BAL-12.5 is to use a bushfire-resisting timber such as Merbau or an E1 timber (see page 8), or suitably fire-retardant (FR) treated timber, at least close to the house. After the first 300mm use normal treated pine decking.

Individual state and territory requirements may exist for this Bushfire Attack Level. Please refer to Adoption AS 3959-2009 by the various Australian states and territories (page 4) for guidance.

BAL-12.5 requirements summary

Enclosed or unenclosed* subfloor spaces	
<ul style="list-style-type: none"> posts, stumps, columns, etc 	All durable timber species and suitably preservative-treated timbers as usual.
<ul style="list-style-type: none"> floor bearers, joists & flooring 	All timber species and engineered timber products as usual.
Internal framing	All timber species and engineered timber products as usual.
Internal joinery	Including doors, wall lining, ceiling linings, flooring over concrete slabs, staircases, etc – all timber as usual.
Fascia and bargeboards	Timber as usual.
Eaves lining	Fibre cement or timber as usual.
Tiled roof	Framing – all timber species and engineered timber framing members as usual.
fully sarked	Fully sarked with a sarking flammability index of not more than 5 <ul style="list-style-type: none"> install sarking directly below the tile battens ensure that the sarking covers the entire roof area, including ridges, and is extended into gutters and valleys, with no gaps greater than 3 mm where the sarking meets fascias, gutters, valleys, etc.
Sheet roof	Framing – all timber species and engineered timber framing members as usual.
fully sarked	Fully sarked, with a sarking flammability index of not more than 5. Install as for a tiled roof (above), except that foil-backed insulation blankets may be installed over battens; and any gaps greater than 3 mm are to be sealed with one or a combination of: <ul style="list-style-type: none"> mesh made of corrosion-resistant steel, bronze or aluminium with a maximum 2 mm aperture, or mineral wool, or other non-combustible material

The simplest solution is to lift windows to 400 mm or more above any external surface which may collect smouldering embers or burning debris (ground, deck or balcony, carport roof, etc).

BAL-12.5 requirements summary

Windows, shutters and screens	The full cover option gives you timber frames and glazing as usual for all windows: <ul style="list-style-type: none"> completely protect all windows with compliant bushfire shutters or compliant screens
Windows finishing 400 mm or more above an external horizontal surface (see page 6 for definition)	Windows need: <ul style="list-style-type: none"> timber frames as usual annealed glass screens to openable parts
Windows finishing closer than 400 mm to an external surface (see page 6 for definition)	Windows need: <ul style="list-style-type: none"> Frames – bushfire-resisting timber or timber species from E2 list (see page 8) Glazing – 4 mm Grade A safety glass Screens – openable parts screened with a mesh made of corrosion resistant steel, bronze or aluminium with a maximum 2 mm aperture
External walls, lightweight cladding	Framing members – all structural timber as usual.
Cladding materials	Weatherboards, ply sheeting, fibre cement treatments etc.
Lower 400 mm of a wall near an external surface (see page 15 and 16)	Use cladding that is: <ul style="list-style-type: none"> a bushfire-resisting timber or a timber species from E1 or a timber log wall (see page 8) or made from a non-combustible material or fibre cement at least 6 mm thick or any combination of the above materials
400 mm and above an external surface (see page 6 for definition)	Timber and timber products as usual.
External walls, heavyweight cladding	Framing members – all structural timber as usual.
Cladding materials	Brick veneer, blockwork, stone, stone cladding, etc – no special requirements.
External side-hung doors	
Protected doors	The full cover option gives you timber doors and joinery as usual for external side-hung doors: <ul style="list-style-type: none"> completely protect doors and door frames with compliant bushfire shutters or compliant screens
Unprotected doors, unglazed	The main concern is protecting the bottom 400 mm section of the door. The alternatives are: <ul style="list-style-type: none"> using solid timber, having a minimum thickness of 35 mm for the lower 400 mm or attaching a non-combustible external kick-plate for the lower 400 mm to a solid or hollow-core or installing a door constructed of non-combustible materials

BAL-12.5 requirements summary (continued)

Unprotected doors, glazed	<p>Install a fully-framed glazed door where the framing is:</p> <ul style="list-style-type: none"> • bushfire-resisting timber or • a timber species from E2 (e.g. Victorian Ash, or a suitably fire retardant treated timber) <p>Glazing in unprotected doors needs to be</p> <ul style="list-style-type: none"> • 4 mm Grade A safety glass
Unprotected door frames – lower 400 mm	At least the lower 400 mm of the door frame needs to be either a bushfire-resisting timber or a timber species from E2 (e.g. Victorian Ash or a suitably fire-retardant (FR) treated timber)
External sliding doors	
Protected doors	<p>The full cover option gives you timber frames and standard glazing as usual</p> <ul style="list-style-type: none"> • completely protect all external sliding doors with compliant bushfire shutters or compliant screens
Unprotected doors – glazing	<ul style="list-style-type: none"> • Grade A safety glass
Unprotected doors – joinery	<ul style="list-style-type: none"> • Ensure the sliding door is tight-fitting in its frame • Use either a bushfire-resisting timber or timber species from E2 (eg. Victorian Ash or a suitably fire-retardant (FR) treated timber)
Unprotected doors – screening	<p>In this case there is no requirement to screen the openable part of the sliding door. It is assumed it will be closed during a bushfire event.</p> <p>If you do screen it, use a mesh or perforated sheet made of corrosion-resistant steel, bronze or aluminium.</p>
Enclosed subfloor spaces of verandas, decks, steps, ramps and landings	
Supports	Timber and timber products as usual.
Framing	Timber and timber products as usual.
Lightweight cladding wall enclosing the sub-floor space	<p>For the first 400 mm above a 'horizontal' surface you have the same options as for external walls.</p> <p>Use cladding that is:</p> <ul style="list-style-type: none"> • a bushfire-resisting timber or • a timber species from E1 or • made from a non-combustible material or • fibre cement at least 6 mm thick or • any combination of the above materials
Decking with enclosed or unenclosed sub-floor	
Decking more than 300 mm from a glazed element	Use timber as usual, e.g. treated pine.
Decking less than 300 mm (measured horizontally) from a glazed element	<p>The decking closest to a window (less than 400 mm above the deck) or glazed door needs to be of the following materials:</p> <ul style="list-style-type: none"> • a bushfire-resisting timber (e.g. Merbau) or • a timber species from E1 (e.g. Grey Ironbark) or • a non-combustible material (e.g. slate or ceramic tiles) <p>This first 300 mm (measured horizontally) can be achieved with a few planks of the specified timbers, or a row of 300 mm tiles laid on top of, or as an inset with, your normal treated pine decking. (see BAL-12.5 Diagrams 1 and 2 on page 13).</p>

For the simplest solution decking can be a bushfire-resisting timber such as Merbau or an E1 timber.

BAL-12.5 diagrams 1 and 2 show a mixed material decking solution using a tile or slate insert for the first 300 mm of decking near a glazed door or window.

A simpler solution is to use a fire-retardant treated, E1 or bushfire-resisting timber species for the first 300 mm close to the house.

'Decking' includes steps, porches, etc (see page 6)

BAL-12.5 Diagram 1: Plan View
Mixed material decking solution

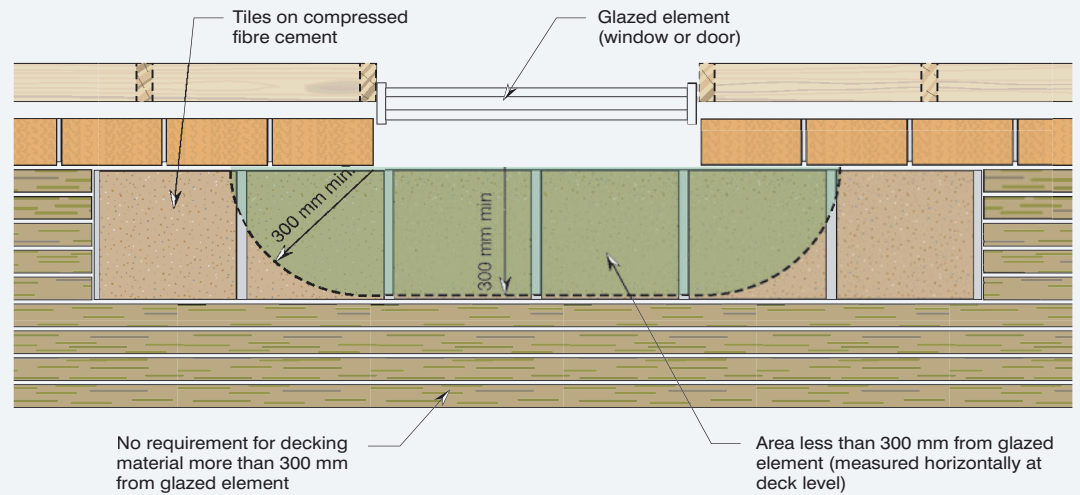

BAL-12.5 Diagram 2: Elevation View.
Mixed material decking solution

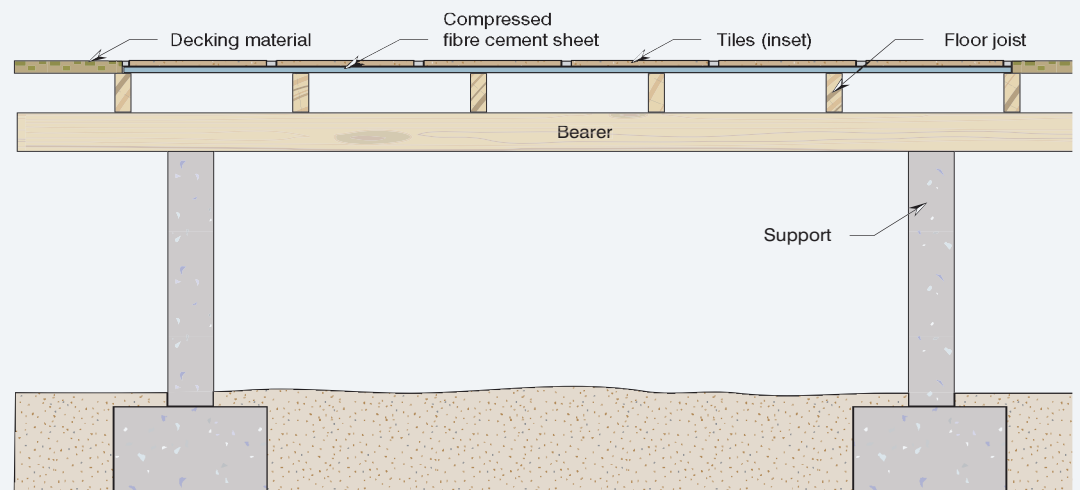

Building designers and builders have a duty to inform building owners of the design, materials and building system obligations of the BAL of their site under AS 3959–2009 and how this will affect future repairs, replacements, extension or renovation.

BAL–12.5 requirements summary (continued)

Balustrades and handrails	Timber as usual.
Garages, carports, verandas and similar roofed structures	The Standard looks to the roof elements of these attached and adjacent structures, any separation from the main building's roof cavity and the fire resistance of the house wall to which they will abut or be near.
When an adjacent (closer than 6 metres) or attached roofed structure is separated from the main building by a fire rated (see page 15) wall that extends to the underside of a non-combustible roof covering	All structural timber products as usual.
When the roof of an attached structure is separated from the roof space of the main building by a complying external wall	<ul style="list-style-type: none"> • All structural timber products as usual • Roof covering must be non-combustible
The separation between the house and adjacent building is 6 metres or more.	All structural timber products as usual.
Pergolas and similar unroofed structures (attached and adjacent)	The Standard makes no specific mention of these, therefore specify timber as usual.



BAL-19

BAL-19 sites have been identified as having an increasing level of predicted ember attack and burning debris ignited by wind-borne embers. The '19' refers to an increasing heat flux, not greater than 19 kW/m².

All traditional timber framing products and systems can be used, along with the usual timber species and treated pine for decks (bearers and joists), balustrades, handrails, finials, pergolas, etc.

It should be noted that you can still build with a timber sub-floor, rather than a concrete slab, for less damage to the site, a smaller carbon footprint and all the convenience and comfort of building off the ground. *Note: when building with an unenclosed sub-floor, storage of combustible materials in the sub-floor space should be avoided.

The simplest solution for decking at BAL-19 is to use a bushfire-resisting timber such as Merbau or an E1 timber (see page 8), or suitably fire-retardant (FR) treated timber, at least close to the house. After the first 300 mm use normal treated pine decking.

This is the last BAL at which E2 timbers can be used for windows and doors.

Stronger, thicker glass is required for unprotected glazed doors and windows.

Individual state and territory requirements may exist for this Bushfire Attack Level. Please refer to Adoption AS 3959-2009 by the various Australian states and territories (page 4) for guidance.

The simplest solution on many sites will be to build well off the ground (400 mm or more). This disturbs the natural drainage as little as possible and keeps your top soil on your block. When homeowners use an unenclosed subfloor space for storage they should consider possible combustibility e.g. stacks of old newspapers, cardboard packing materials, etc. This area should also be kept free of litter, especially in bushfire season.

BAL-19 requirements summary

Enclosed or unenclosed* subfloor spaces	
• posts, stumps, columns, etc	All durable timber species and suitably preservative treated timbers as usual.
• floor bearers & joists & flooring	All timber species and engineered timber products as usual.
Internal framing	All timber species and engineered timber products as usual.
Internal joinery	Including doors, wall lining, ceiling linings, flooring over concrete slabs, staircases, etc – all timber as usual.
Fascia and bargeboards	Timber as usual.
Eaves lining	Fibre cement or timber as usual.
Tiled roof	Framing – all timber species and engineered timber framing members as usual.
fully sarked	Fully sarked with a sarking flammability index of not more than 5. Install sarking directly below the tile battens: <ul style="list-style-type: none"> • ensure that the sarking covers the <i>entire roof area</i>, including ridges, and is extended into gutters and valleys, with no gaps greater than 3 mm where the sarking meets fascias, gutters, valleys, etc
Sheet roof	Framing – all timber species and engineered timber framing members as usual.
fully sarked	Fully sarked with a sarking flammability index of not more than 5. Install as for a tiled roof (above), except that foil-backed insulation blankets may be installed over battens; and any gaps greater than 3 mm are to be sealed with one or a combination of: <ul style="list-style-type: none"> • mesh made of corrosion resistant steel, bronze or aluminium with a maximum 2 mm aperture or • mineral wool or • other non-combustible material

BAL-19 requirements summary (continued)

Windows, shutters and screens	The full cover option gives you timber frames and glazing as usual for all windows: <ul style="list-style-type: none"> completely protect all windows with compliant bushfire shutters or compliant screens
Windows finishing 400 mm or more above an external horizontal surface <i>(see page 6 for definition)</i>	Windows need: <ul style="list-style-type: none"> timber frames as usual annealed glass screens to all parts of window
Windows finishing closer than 400 mm to an external horizontal surface <i>(see page 6 for definition)</i>	Windows need: <ul style="list-style-type: none"> Frames – bushfire-resisting timber or timber species from E2 Glazing – 5 mm toughened glass Screening to openable parts
Screens	Mesh made of corrosion resistant steel, bronze or aluminium with a maximum 2mm aperture
External walls, lightweight cladding	Framing members – timber as usual.
Cladding materials	Weatherboards, ply sheeting, fibre cement treatments etc.
Lower 400 mm of a wall near an external surface <i>(see page 6 for definition)</i>	Use cladding that is: <ul style="list-style-type: none"> a bushfire-resisting timber or a timber species from E1 or a timber log wall <i>(see page 8)</i> or made from a non-combustible material or fibre cement at least 6mm thick or any combination of the above materials.
400 mm and above an external surface <i>(see page 6 for definition)</i>	Timber and timber products as usual.
External walls, heavyweight cladding	Framing members – all structural timber as usual.
Cladding materials	Brick veneer, blockwork, stone, stone cladding, etc – no special requirements.
External side-hung doors	
Protected doors	The full cover option gives you timber doors and joinery as usual for external side-hung doors: <ul style="list-style-type: none"> completely protect doors and door frames with compliant bushfire shutters or compliant screens
Unprotected doors, unglazed	The main concern is protecting the section from 400 mm down to the nearest 'horizontal' surface. The alternatives are: <ul style="list-style-type: none"> using solid timber, having a minimum thickness of 35 mm, for the lower 400 mm or attaching a non-combustible external kick-plate for the lower 400 mm to a solid or hollow-core door or a door constructed of non-combustible materials
Unprotected doors, glazed	Install a fully-framed glazed door where the framing is bushfire-resisting timber or a timber species from E2 (e.g. Victorian Ash, or a suitably fire-retardant (FR) treated timber.) <ul style="list-style-type: none"> Glazing in unprotected doors needs to be 5mm toughened glass.
Unprotected door frames – lower 400 mm	At least the lower 400 mm of the door frame needs to be either a bushfire-resisting timber or a timber species from E2 (e.g. Victorian Ash or a suitably fire-retardant (FR) treated timber.)

Owners should be supplied with copies of all documentation relating to compliance to the Standard of particular materials and building systems. These should be passed on to new the owners when the property is sold.

BAL-19 requirements summary (continued)

External sliding doors	
Protected doors	The full cover option gives you timber frames and standard glazing as usual: <ul style="list-style-type: none"> completely protect all external sliding doors with compliant bushfire shutters or compliant screens.
Unprotected doors – glazing	<ul style="list-style-type: none"> 5 mm toughened glass.
Unprotected doors – joinery	<ul style="list-style-type: none"> Ensure the sliding door is tight-fitting in its frame. Use either a bushfire-resisting timber or timber species from E2 (e.g. Victorian Ash or a suitably fire-retardant (FR) treated timber.
Unprotected doors – screening	In this case there is no requirement to screen the openable part of the sliding door. It is assumed it will be closed during a bushfire event. <p>If you do screen it, use a mesh or perforated sheet made of corrosion-resistant steel, bronze or aluminium.</p>
Enclosed and Unenclosed subfloor spaces of verandas, decks, steps, ramps & landings	
Supports	Timber and timber products as usual.
Framing	Timber and timber products as usual.
Lightweight cladding wall enclosing a sub-floor space	For the first 400 mm above a horizontal surface you have the same options as for external walls. <p>Use cladding that is:</p> <ul style="list-style-type: none"> a bushfire-resisting timber or a timber species from E1 or made from a non-combustible material or fibre cement at least 6 mm thick or any combination of the above materials.
Decking with enclosed or unenclosed sub-floor	
Decking more than 300 mm from a glazed element	Use timber, eg. treated pine, as usual.
Decking less than 300 mm (measured horizontally) from a glazed element	The decking closest to a window (less than 400 mm above the deck) or glazed door needs to be of the following materials: <ul style="list-style-type: none"> a bushfire-resisting timber (e.g. Merbau) or a timber species from E1 (e.g. Grey Ironbark) or a non-combustible material (e.g. slate or ceramic tiles) <p>This first 300 mm (measured horizontally) can be achieved with a few planks of the specified timbers, or a row of 300 mm tiles laid on top of, or as an inset with, your normal treated pine decking. (see BAL-19 Diagrams 1 & 2, page 18).</p>
Garages, carports, verandas and similar roofed structures	
When an adjacent (closer than 6 metres) or attached roofed structure is separated from the main building by a fire rated (see p15) wall that extends to the underside of a non-combustible roof covering	All structural timber products as usual.

FRL: Fire Resistance Level is the grading period in minutes for three criteria: structural adequacy/integrity/insulation
See page 6 for more information.

BAL-12.5 diagrams 1 and 2 show a mixed material decking solution using a tile or slate insert for the first 300 mm of decking near a glazed door or window.
A simpler solution is to use a fire retardant treated, E1 or bushfire-resisting timber species for the first 300 mm close to the house.
'Decking' includes steps, porches, etc (see page 6)

BAL-19 requirements summary (continued)

When the roof of an attached structure is separated from the roof space of the main building by a complying external wall

- All structural timber products as usual.
- Roof covering must be non-combustible.

The separation between the house and adjacent building is 6 metres or more.

All structural timber products as usual.

Pergolas and similar unroofed structures
(attached and adjacent)

The Standard makes no specific mention of these, therefore specify timber as usual.

Balustrades and handrails

Timber as usual.

BAL-19 Diagram 1: Plan View
Mixed material decking solution

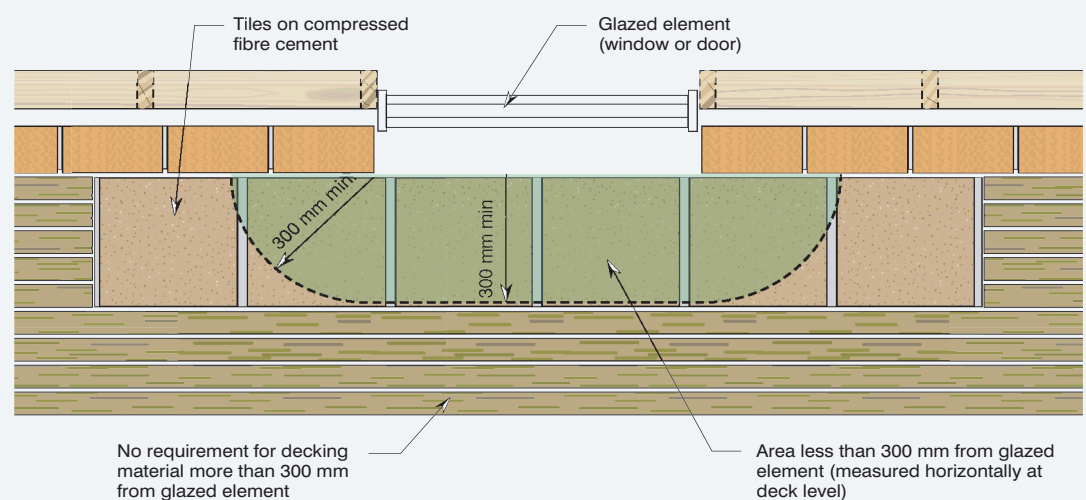

BAL-19 Diagram 2: Elevation View.
Mixed material decking solution

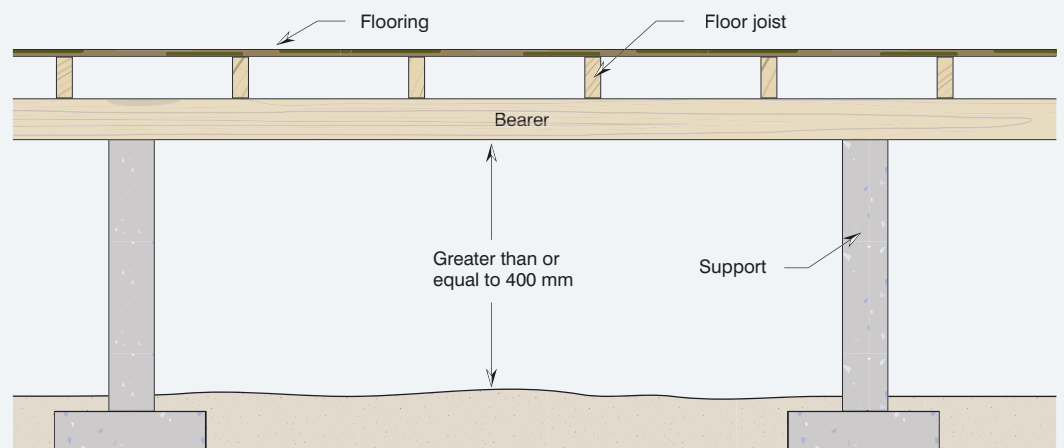

Fire-grade plasterboard

Where a carport or similar roofed structure, such as a veranda, is attached or closer than 6 metres, BAL-19 walls need to be built as a complying external wall (meeting the construction requirements of the designated BAL) that extends to the underside of a non-combustible roof covering or a fire-rated wall (see BAL-FZ).

BAL-29

At BAL-29 there is an increasing level of chance of ember attack and burning debris ignited by wind-borne embers. The '29' refers to the chance of an increasing heat flux not greater than 29 kW/m².

Bushfire-resisting timbers (see page 8) and fire-retardant (FR) treated timbers are the only timbers to be used for exposed applications. For full window and glazed door protection, timber shutters (e.g. red ironbark) suitable to BAL-29 are available.

Always check external building materials and systems have been tested and comply with Standard requirements.

Individual state and territory requirements may exist for this Bushfire Attack Level. Please refer to Adoption AS 3959-2009 by the various Australian states and territories (page 4) for guidance.

The simplest solution on many sites will be to build well off the ground (400 mm or more). This disturbs the natural drainage as little as possible and keeps your topsoil on your block. When homeowners use an unenclosed subfloor space for storage they should consider possible combustibility, e.g. stacks of old newspapers, cardboard packing materials etc. This area should also be kept free of litter, especially in bushfire season.

BAL-29 requirements summary

Enclosed subfloor spaces	
• posts, stumps, columns, etc	All durable timber species and suitably preservative treated timbers as usual.
• floor bearers & joists & flooring	All timber species and engineered timber products as usual.
Unenclosed subfloor spaces	
• posts, stumps, columns etc	Bushfire-resisting timber or non-combustible material.
• floor bearers and joists	
400 mm or more above the ground	All timber species and engineered timber products as usual. (see BAL-29 Diagram 1, page 22)
less than 400 mm from the ground	Materials need to be: <ul style="list-style-type: none"> • a bushfire-resisting timber or • timber, particleboard or plywood flooring with the underside lined with either mineral wool insulation or sarking or • a non-combustible material (e.g. fibre cement flooring sheets).
Internal framing	All timber species and engineered timber products as usual.
Internal joinery	Including doors, wall lining, ceiling linings, flooring over concrete slabs, staircases, etc. – all timber as usual.
Fascia and bargeboards	<ul style="list-style-type: none"> • a bushfire-resisting timber or • metal fixed at 450 mm centres
Eaves lining	<ul style="list-style-type: none"> • a bushfire-resisting timber or • 4.5 mm fibre cement
Tiled roof	Framing – all timber species and engineered timber framing members as usual.
fully sarked	Fully sarked with a sarking flammability index of not more than 5. Install sarking directly below the tile battens <ul style="list-style-type: none"> • ensure that the sarking covers the <i>entire roof area</i>, including ridges, and is extended into gutters and valleys, with no gaps where the sarking meets fascias, gutters, valleys, etc.

BAL-29 requirements summary (continued)

Sheet roof	Framing – all timber species and engineered timber framing members as usual.
fully sarked	Fully sarked, with a sarking with a flammability index of not more than 5. Install as for a tiled roof (above), except that foil-backed insulation blankets may be installed over battens; and any gaps greater than 3 mm are to be sealed with one or a combination of: <ul style="list-style-type: none"> • mesh made of corrosion-resistant steel, bronze or aluminium with a maximum 2 mm aperture or • mineral wool or • other non-combustible material.
Windows, shutters and screens	The full cover option gives you timber frames and glazing as usual for all windows: <ul style="list-style-type: none"> • completely protect all windows with compliant bushfire shutters.
Windows finishing 400 mm or more above an external surface horizontal surface <i>(see page 6 for definition)</i>	<ul style="list-style-type: none"> • Window frames and joinery are to be made from a bushfire-resisting timber • Glazing is to be 5 mm toughened glass • Screen openable parts with a mesh made of corrosion-resistant steel, bronze or aluminium with a maximum 2 mm aperture.
Windows finishing closer than 400 mm to an external surface horizontal surface <i>(see page 6 for definition)</i>	<ul style="list-style-type: none"> • Window frames and joinery are to be made from a bushfire-resisting timber • Glazing is to be 5 mm toughened glass • Screening to openable parts
Screens	Mesh made of corrosion resistant steel, bronze or aluminium with a maximum 2 mm aperture
External walls, lightweight cladding	Framing members – timber as usual.
Cladding materials	<ul style="list-style-type: none"> • a bushfire-resisting timber, with a vapour-permeable sarking attached to the <i>outside</i> of the frame or • a timber log wall <i>(see page 8)</i> or • fibre cement that is at least 6 mm thick
External walls, heavyweight cladding	Framing members – all structural timber as usual.
Cladding materials	Brick veneer, blockwork, stone, stone cladding, etc – no special requirements.
External side-hung doors	
Protected doors	The full cover option gives you timber doors and joinery as usual for external side-hung doors: <ul style="list-style-type: none"> • completely protect doors and door frames with compliant bushfire shutters or compliant screens.
Unprotected doors, unglazed	The main concern is protecting the section from 400 mm down to the nearest 'horizontal' surface. The alternatives are: <ul style="list-style-type: none"> • using solid timber, having a minimum thickness of 35 mm, for the lower 400 mm or • attaching a non-combustible external kick-plate for the lower 400 mm to a solid or hollow-core door or • a door constructed of non-combustible materials

Timber shutters tested as suitable to BAL-29 are available. Always check the materials and system have been tested and comply with Standard requirements.

BAL-29 requirements summary (continued)

Unprotected doors, glazed	Install a fully-framed glazed door where: <ul style="list-style-type: none"> the framing is a bushfire-resisting timber glazing is 6 mm toughened glass with the lower 400 mm fitted with a compliant screen.
Unprotected door frames	The door frame material needs to be a bushfire-resisting timber.
External sliding doors	The full cover option gives you timber frames and standard glazing as usual <ul style="list-style-type: none"> completely protect all external sliding doors with compliant bushfire shutters or compliant screens
Unprotected doors – glazing	<ul style="list-style-type: none"> 6 mm toughened glass
Unprotected doors – joinery	<ul style="list-style-type: none"> Ensure the sliding door is tight-fitting in its frame Use a bushfire-resisting timber
Unprotected doors – screening	In this case there is no requirement to screen the openable part of the sliding door. It is assumed it will be closed during a bushfire event. If you do screen it, use a mesh or perforated sheet made of corrosion-resistant steel, bronze or aluminium.
Enclosed subfloor spaces of verandas, decks, steps, ramps and landings	
Supports	Timber and timber products as usual.
Framing	Timber and timber products as usual.
Lightweight cladding wall enclosing a sub-floor space	For the first 400 mm above a horizontal surface use cladding that is: <ul style="list-style-type: none"> a bushfire-resisting timber or made from a non-combustible material or fibre cement at least 6 mm thick or a mesh made of corrosion-resistant steel, bronze or aluminium with a maximum 2 mm aperture or any combination of the above materials
Unenclosed subfloor spaces of verandas, decks, steps, ramps and landings	
Supports	<ul style="list-style-type: none"> a bushfire-resisting timber or a non-combustible material
Framing	<ul style="list-style-type: none"> a bushfire-resisting timber or a non-combustible material
Decking with enclosed or unenclosed sub-floor	Use either a bushfire-resisting timber (such as Merbau, Silvertop Ash) or a non-combustible material (such as slate, tiles).
Garages, carports, verandas and similar roofed structures	The Standard looks to the roof elements of these attached and adjacent structures, any separation from the main building's roof cavity and the fire resistance of the house wall to which they will abut or be near.
When an adjacent (closer than 6 metres) or attached roofed structure is separated from the main building by a fire rated (see p15) wall that extends to the underside of a non-combustible roof covering	All structural timber products as usual.

You can build to the requirements of a higher BAL

Evolution of the Standard AS 3959 – Prescriptive bushfire standard
Edition One 1991 – Ember attack only, no assessment.
Edition Two 1999 – Four construction levels and assessment method; Ember and flame attack.
Edition Three 2009 – Six construction levels; two assessment methods; includes ember and flame attack with measurable criteria and test methods.

BAL-29 requirements summary (continued)

When the roof of an attached structure is separated from the roof space of the main building by a complying external wall

- Build roof frame with bushfire-resisting timber or use all structural timber roof framing products as usual lined on the underside of the rafters with 6 mm fibre cement sheeting
- Roof covering must be a non-combustible material
- The standard currently makes no direct reference to exposed beams and supporting posts. We recommend the use of bushfire-resisting timber

The separation between the house and adjacent building is 6 metres or more.

All structural timber products as usual.

Pergolas and similar unroofed structures
(attached and adjacent)

The Standard makes no specific mention of these, therefore specify timber as usual.

Balustrades and handrails

125 mm or more from glazing or a combustible wall, **or** against a non-combustible wall

Use timber as usual.

Less than 125 mm from glazing **or** a combustible wall

Use either a bushfire-resisting timber **or** a non-combustible material, such as steel.

BAL-29 Diagram 1: Elevation View.

Standard subfloor construction when building above the ground by 400 mm or more.
Use traditional and engineered wood products as usual

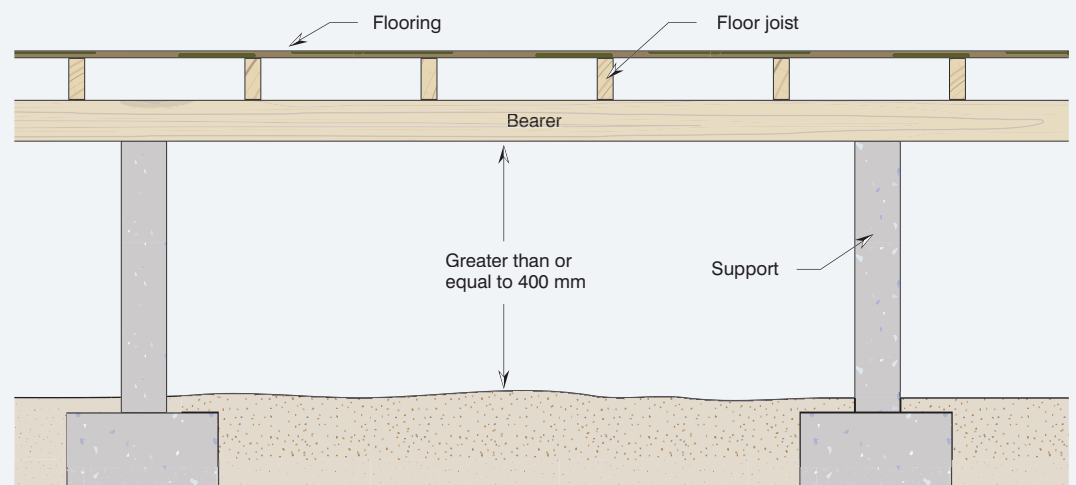

Fire-grade plasterboard

Where a carport or similar roofed structure, such as a veranda, is attached or closer than 6 metres, BAL-29 walls need to be built as a complying external wall (meeting the construction requirements of the designated BAL) that extends to the underside of a non-combustible roof covering or a fire-rated wall (see BAL-FZ).

BAL-40

The second-highest Bushfire Attack Level, BAL-40 has a possibility of ember attack and burning debris ignited by wind-borne embers and an increased likelihood of exposure to bushfire flames. The '40' comes from an increasing heat flux not greater than 40 kW/m²

The use of fire-resistant lining materials, thicker or treated glass, special shutters and building systems increase protection. At BAL-40 a number of building materials and systems used for the building envelope (external components) need to have met the specific test methods for building elements of construction exposed to simulated bushfire attack, as indicated in AS 1530 Part 8.1 – Radiant heat and small flaming sources.

Individual state and territory requirements may exist for this Bushfire Attack Level. Please refer to Adoption AS 3959-2009 by the various Australian states and territories (page 4) for guidance.

BAL-40 requirements summary

Enclosed subfloor spaces	
• posts, stumps, columns, etc	All durable timber species and suitably preservative treated timbers as usual.
• floor bearers & joists & flooring	All timber species and engineered timber products as usual.
Unenclosed subfloor spaces	
• posts, stumps, columns etc	<ul style="list-style-type: none"> • non-combustible material or • a system or material which complies with AS1530.8.1.
• floor bearers, joists and flooring	<ul style="list-style-type: none"> • timber members must have the underside lined with a non-combustible material (e.g. fibre cement sheet, see BAL-40 Diagram 1, page 27) or • a non-combustible material or system or • material or system which complies with AS1530.8.1
Internal framing	All timber species and engineered timber products as usual.
Internal joinery	Including doors, wall lining, ceiling linings, flooring over concrete slabs, staircases, etc – all timber as usual.
Fascia and bargeboards	<ul style="list-style-type: none"> • material or system which complies with AS1530.8.1. (see BAL-40 Diagram 1, page 27)
Eaves lining	<ul style="list-style-type: none"> • 6 mm fibre cement or • 6 mm calcium silicate.
Tiled roof	Framing – all timber species and engineered timber framing members as usual.
fully sarked	<p>Fully sarked with a sarking with a flammability index of not more than 5. Install sarking directly below the tile battens:</p> <ul style="list-style-type: none"> • ensure that the sarking covers the <i>entire roof area</i>, including ridges, and is extended into gutters and valleys, with no gaps where the sarking meets fascias, gutters, valleys, etc.
Sheet roof	Framing – all timber species and engineered timber framing members as usual.
fully sarked	<p>Fully sarked with a sarking with a flammability index of not more than 5.</p> <p>Install as for a tiled roof (above), except that foil-backed insulation blankets may be installed over battens; and any gaps greater than 3 mm are to be sealed with one or a combination of:</p> <ul style="list-style-type: none"> • mesh made of corrosion resistant steel or bronze with a maximum 2 mm aperture or • mineral wool or • other non-combustible material

For this extreme BAL we recommend that all subfloors are enclosed.

BAL-40 requirements summary (continued)

Windows, shutters and screens	The full cover option gives you timber frames and glazing as usual for all windows: <ul style="list-style-type: none"> • completely protect all windows with compliant bushfire shutters
Windows without compliant shutters	<ul style="list-style-type: none"> • Window frames – metal • Glazing – 6 mm toughened glass • Screens – to all parts of window with a compliant material • Seals – materials with a flammability index no greater than 5 or silicone
External walls, lightweight cladding	Framing members – timber as usual.
Cladding materials	<ul style="list-style-type: none"> • a system complying with AS 1530.8.1. The moisture-resistant fire-grade plasterboard and timber system we recommend exceeds the requirement for the next BAL (BAL-FZ) and still enables the attractive appearance of timber (see pages 15 & 16) or • steel sheet (sarking required) or • fibre cement cladding, with a minimum thickness of 9 mm (sarking required)
External walls, heavyweight cladding	Framing members – all structural timber as usual.
Cladding materials	Brick veneer, blockwork, stone, stone cladding, etc – no special requirements.
External side-hung doors	
Protected doors	The full cover option gives you timber doors, glazing and joinery as usual for external side-hung doors: <ul style="list-style-type: none"> • completely protect doors and door frames with compliant bushfire shutters
Unprotected doors, unglazed	The main concern is protecting the section from 400 mm down to the nearest 'horizontal' surface. The alternatives are: <ul style="list-style-type: none"> • using solid timber, having a minimum thickness of 35 mm and the lower 400 mm protected behind a metal framed screen door with a mesh or perforated sheet made of corrosion resistant steel or bronze, with a maximum 2 mm aperture or • use a non-combustible material, such as steel
Unprotected doors, glazed	Install a fully-framed glazed door where: <ul style="list-style-type: none"> • the framing is metal • glazing is 6 mm toughened glass with the lower 400 mm fitted with a compliant screen
Unprotected door frames	The door frame material needs to be a metal.
Seals	Materials with a flammability index no greater than 5 or silicone.

BAL-40 requirements summary (continued)

External sliding doors	
Protected doors	The full cover option gives you timber frames and standard glazing as usual: <ul style="list-style-type: none"> completely protect all external sliding doors with compliant bushfire shutters or compliant screens
Unprotected doors – glazing	<ul style="list-style-type: none"> FRL – /30/ – (see page 6 for definition) or 6 mm toughened glass behind screens to openable and fixed doors
Unprotected doors – joinery	<ul style="list-style-type: none"> Ensure the sliding door is tight-fitting in its frame. Use a metal material
Unprotected doors – screening	In this case there is no requirement to screen the openable part of the sliding door. It is assumed it will be closed during a bushfire event. If you do screen it, use a mesh or perforated sheet made of corrosion-resistant steel or bronze.
Seals	Materials with a flammability index no greater than 5 or silicone.
Enclosed subfloor spaces of verandas, decks, steps, ramps and landings	
Supports	Timber and timber products as usual.
Framing	Timber and timber products as usual.
Lightweight cladding wall enclosing a sub-floor space	For the first 400 mm above a horizontal surface use cladding that is: <ul style="list-style-type: none"> a system complying with AS 1530.8.1. The moisture resistant fire grade plasterboard and timber system we recommend exceeds even the requirement for the next BAL (BAL-FZ) and still enables the attractive appearance of timber. (see page 32) or steel sheet (sarking required) or fibre cement cladding, with a minimum thickness of 9 mm (sarking required) Screen all openings greater than 3 mm with a corrosion-resistant steel or bronze mesh or perforated sheet with a maximum aperture of 2 mm.
Unenclosed subfloor spaces of verandas, decks, steps, ramps and landings	
	(see BAL-40 Diagram 2 on page 27)
Supports	<ul style="list-style-type: none"> a system complying with AS 1530.8.1 or a non-combustible material, e.g. concrete.
Framing	<ul style="list-style-type: none"> a system complying with AS 1530.8.1 or a non-combustible material, e.g. concrete.
Decking with enclosed or unenclosed sub-floor	
	Decking to have no gaps and be <ul style="list-style-type: none"> a system complying with AS 1530.8.1 or non-combustible material, e.g. slate or tiles

Building owners should be supplied with copies of all documentation relating to compliance to the Standard of particular materials and building systems. These should be passed on to new the owners when the property is sold.

BAL-40 requirements summary (continued)

Garages, carports, verandas and similar roofed structures

The standard looks to the roof elements of these attached and adjacent structures, any separation from the main building's roof cavity and the fire resistance of the house wall to which they will abut or be near.

When an adjacent (closer than 6 metres) or attached roofed structure is separated from the main building by a fire rated (see p15) wall that extends to the underside of a non-combustible roof covering

All structural timber products as usual.

When the roof of an attached structure is separated from the roof space of the main building by a complying external wall

- Use all structural timber roof framing products as usual lined on the underside of the rafters with 6 mm fibre cement sheeting
- Roof covering must be a non-combustible material
- The Standard currently makes no direct reference to exposed beams and supporting posts. We recommend the use of bushfire-resisting timber

The separation between the house and adjacent building is 6 metres or more.

All structural timber products as usual.

Pergolas and similar unroofed structures (attached and adjacent)

The Standard makes no specific mention of these, therefore specify timber as usual.

Balustrades and handrails

125 mm or more from glazing or a combustible wall, or against a non-combustible wall

Use timber as usual.

Less than 125 mm from glazing or a combustible wall

Use either a bushfire-resisting timber **or** a non-combustible material, such as steel.

This fascia and eaves system provides a solution for lightweight cladding walls and can be used with other wall systems, such as brick veneer, for improved protection in this vulnerable area.

BAL-40 Diagram 1

Fascia solution for BAL-40 using the flame zone (FZ) tested solution for roof systems.

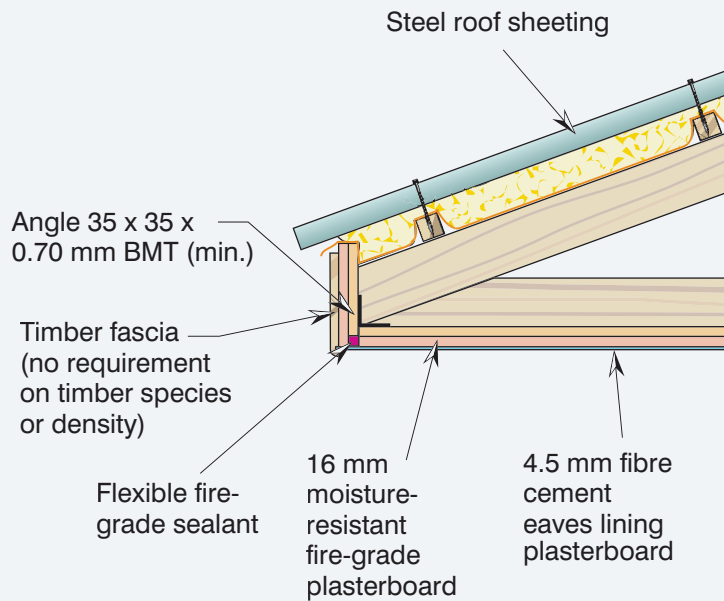

The solution in BAL-40 Diagram 2 uses a subfloor 'ceiling' of fibre cement sheet and non-combustible posts, columns and stumps. A more practical solution is to enclose the subfloor using a complying wall system and normal timber subfloor construction.

BAL-29 Diagram 2: Elevation View.

Unenclosed, lined sub-floor system

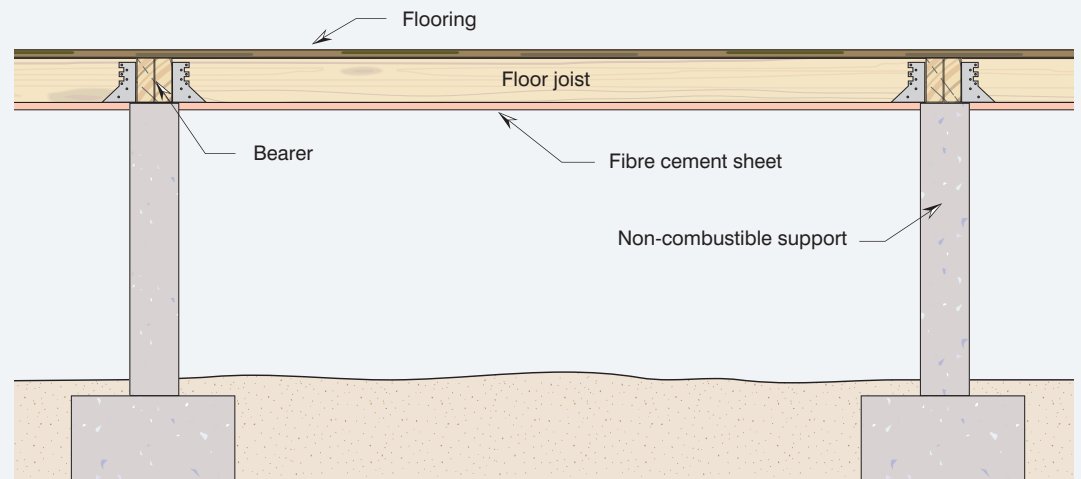

Fire grade plasterboard

For BAL-40 the Standard, AS 3959-2009 stipulates a lightweight cladding wall should comply to AS 1530-2007.8.1. At time of printing we are unaware of any system that has been tested to comply with this requirement. There are, however, building systems that have been tested to the more rigorous requirements of BAL-FZ. Our system is easily constructed utilising a membrane of fire grade plasterboard with the external timber cladding. Just one layer of 16 mm moisture-resistant fire-grade plasterboard in this system achieves twice the required FRL (i.e. 60/60/60). Even higher FRLs can be achieved with more layers of suitable plasterboard, if desired.

For more information refer to pages 32 and 33.

BAL-FZ

This is the highest Bushfire Attack Level (BAL) in AS 3959-2009. Very bushfire-prone, probably in a picturesque bushland setting, a home designated BAL-FZ has a predicted direct exposure risk to flames from a fire front, ember attack and a heat flux greater than 40 kW/m².

Following the Standard, ensuring commonsense maintenance, as well as complying with Wildfire Management Overlays (WMO) and fire authority rules and instructions, are all important. Reduce the potential for bushfire attack and damage by following the Standard's guidelines for building systems and materials and special timber choices.

In areas identified as BAL-FZ (Flame Zone) the building envelope needs extra reinforcement, especially in the most vulnerable places – such as the leading edges of roofs, glazed areas and decks where flames, embers and hot air can penetrate.

For this extreme BAL we recommend that all subfloors are enclosed, with complaint mesh on sub-floor external wall vents.

By ensuring no gaps of more than 3 mm, tight door seals and the most fire-resistant materials it is still possible to have a nice home, using lightweight cladding such as weatherboards, on the exterior. A system using a membrane of moisture-resistant, fire-grade plasterboard gives you a normal choice of exterior cladding looks (*see pages 32 and 33*).

The relevant BAL-FZ test methods for building elements of construction exposed to simulated bushfire attack are available in *AS 1530 Part 8.2 – Large flaming sources*.

The BAL-FZ roofing system needs to comply with AS 1530.8.2 when tested from the outside. AS 3959-2009 provides a deemed-to-satisfy sheet metal roofing system, utilising structural plywood, that is illustrated on pages 35-39. As new timber systems are developed and tested further data sheets available at www.woodsolutions.com.au.

Building designers, those ordering building materials and building surveyors need to ensure they use test reports, issued by Registered Testing Authorities, as quantifiable evidence of the suitability of their performance-based bushfire designs and construction.

Individual state and territory requirements may exist for this Bushfire Attack Level. Please refer to Adoption AS 3959-2009 by the various Australian states and territories (page 4) for guidance.

Building owners should be supplied with copies of all documentation relating to compliance to the Standard of particular materials and building systems. These should be passed on to the new owners when the property is sold.

BAL-FZ requirements summary

Enclosed subfloor spaces	
• posts, stumps, columns, etc	All durable timber species and suitably preservative treated timbers as usual.
• floor bearers & joists & flooring	All timber species and engineered timber products as usual.
Unenclosed subfloor spaces	
• posts, stumps, columns, etc	• a system with FRL of at least 30/-/- and non-combustible or • a system complying with AS 1530.8.2.
• floor bearers, joists and flooring	• a system with FRL of at least 30/30/30 and non-combustible surface material or • protect the underside of combustible floor elements with a 30 minute resistance to incipient spread of fire system or • a system complying with AS 1530.8.2, when tested from the outside.
Internal framing	All timber species and engineered timber products as usual.
Internal joinery	Including doors, wall lining, ceiling linings, flooring over concrete slabs, staircases, etc – all timber as usual.
Fascia and bargeboards	A system complying with AS 1530.8.2. Refer to the first tested system to comply (Ply membrane) (<i>see pages 34-38</i>)

BAL-FZ requirements summary (continued)

Eaves lining	<ul style="list-style-type: none"> a system with FRL – /30/30 or a system complying with AS 1530.8.2. Refer to the first tested system to comply (see page 37)
Tiled roof	<p>Framing – all timber species and engineered timber framing members as usual.</p> <p>The roofing system needs to comply with AS 1530.8.2 when tested from the outside.</p>
Sheet roof	<p>Framing – all timber species and engineered timber framing members as usual.</p> <p>The roofing system needs to comply with AS 1530.8.2 when tested from the outside (see pages 34-38)</p>
Windows, shutters and screens	<p>The full cover option gives you timber frames and glazing as usual for all windows:</p> <ul style="list-style-type: none"> completely protect all windows with bushfire shutters that comply with AS 1530.8.2, when tested from the outside.
Windows without compliant shutters	<p>The openable parts of the window screened with a metal-framed screen with mesh made of corrosion resistant steel or bronze with a maximum 2 mm aperture and be either:</p> <ul style="list-style-type: none"> a window system having FRL of – /30/ – or a window system complying with AS 1530.8.2, when tested from the outside
External walls, lightweight cladding	Framing members – timber as usual.
Cladding materials	<ul style="list-style-type: none"> a system complying with AS 1530.8.2. when tested from the outside or a system having an FRL of 30/30/30 or -/30/30 when tested from the outside <p>The moisture resistant fire-grade plasterboard and timber system we recommend exceeds this requirement and still enables the attractive appearance of timber (see pages 32 & 33).</p>
External walls, heavyweight cladding	Framing members – all structural timber as usual.
Cladding materials	Brick veneer, blockwork, stone, stone cladding, etc – no special requirements.
External side-hung doors	
Protected doors	<p>The full cover option gives you timber doors, glazing and joinery as usual for external side-hung doors</p> <ul style="list-style-type: none"> completely protect doors and door frames with bushfire shutters that comply with AS 1530.8.2, when tested from the outside
Unprotected doors glazed and unglazed	<p>The door system can comply for this BAL by:</p> <ul style="list-style-type: none"> having FRL of – /30/ – or complying with AS 1530.8.2 when tested from the outside
Seals	Materials with a flammability index no greater than 5 or silicone.
External sliding doors	
Protected doors	<p>The full cover option gives you timber frames and standard glazing</p> <ul style="list-style-type: none"> completely protect all external sliding doors with bushfire shutters that comply with AS 1530.8.2 when tested from the outside

Vents in exterior walls need to be protected with a corrosion-resistant steel or bronze mesh with a maximum aperture of 2 mm.

BAL-FZ requirements summary (continued)

Unprotected doors	<p>The door system can comply for this BAL by:</p> <ul style="list-style-type: none"> • having FRL of - /30/ - or • complying with AS 1530.8.2 <p>Ensure the sliding door is tight-fitting in the frames.</p>
Seals	materials with a flammability index no greater than 5 or silicone.
Enclosed subfloor spaces of verandas, decks, steps, ramps and landings	
Supports	Timber and timber products as usual.
Framing	Timber and timber products as usual.
Lightweight cladding wall enclosing a sub-floor space	<ul style="list-style-type: none"> • a system complying with AS 1530.8.2. when tested from the outside or • a system having an FRL of 30/30/30 or -/30/30 when tested from the outside. The moisture-resistant fire-grade plasterboard and timber system we recommend exceeds this requirement and still enables the attractive appearance of timber (see pages 32 and 33). <p>Screen all openings greater than 3 mm with a corrosion resistant steel or bronze mesh or perforated sheet with a maximum aperture of 2 mm.</p>
Unenclosed subfloor spaces of verandas, decks, steps, ramps and landings	
Supports	<ul style="list-style-type: none"> • a system complying with AS 1530.8.2 or • a non-combustible material, e.g. concrete
Framing	<ul style="list-style-type: none"> • a system complying with AS 1530.8.2 or • a non-combustible material, e.g. concrete
Decking with enclosed sub-floor	<p>Decking to have <i>no gaps</i> and be</p> <ul style="list-style-type: none"> • a non-combustible material, such as slate or ceramic tiles, on a compressed fibre cement substrate or • a system which complies with AS 1530.8.2
Decking with unenclosed sub-floor	<p>Decking to be</p> <ul style="list-style-type: none"> • a non-combustible material or • fibre cement sheets or • a system complying with AS 1530.8.2
Garages, carports, verandas and similar roofed structures	The Standard looks to the roof elements of these attached and adjacent structures, any separation from the main building's roof cavity and the fire resistance of the house wall to which they will abut or be near.
When an adjacent (closer than 6 metres) or attached roofed structure is separated from the main building by a fire rated (see p15) wall that extends to the underside of a non-combustible roof covering	All structural timber products as usual.
When the roof of an attached structure is separated from the roof space of the main building by a complying external wall	<ul style="list-style-type: none"> • Use structural timber roof framing products as usual lined on the underside of the rafters with 6 mm fibre cement sheeting • Roof covering must be a non-combustible material • The standard currently makes no direct reference to exposed beams and supporting posts. We recommend the use of bushfire-resisting timber

BAL-FZ requirements summary (continued)

The separation between the house and adjacent building is 6 metres or more.	All structural timber products as usual.
Pergolas and similar unroofed structures (attached and adjacent)	The Standard makes no specific mention of these, therefore any usual timber can be specified. At this BAL we recommend a bushfire-resisting timber or pine treated for in-ground use with a suitable fire-retardant coating.
Balustrades and handrails 125 mm or more from glazing or a combustible wall, or against a non-combustible wall	Use timber as usual.
Less than 125 mm from glazing or a combustible wall	Use a non-combustible material, such as steel.

At this BAL an unenclosed subfloor 'ceiling' requires a system which will give at least a 30 minute resistance to incipient spread of fire.

BA - FZ Diagram 1: Sectional view.

Deemed-to-satisfy sheet metal roof and FRL 60/60/60 wall system.

Note: AS 3959-2009 simply requires a wall FRL of 30/30/30

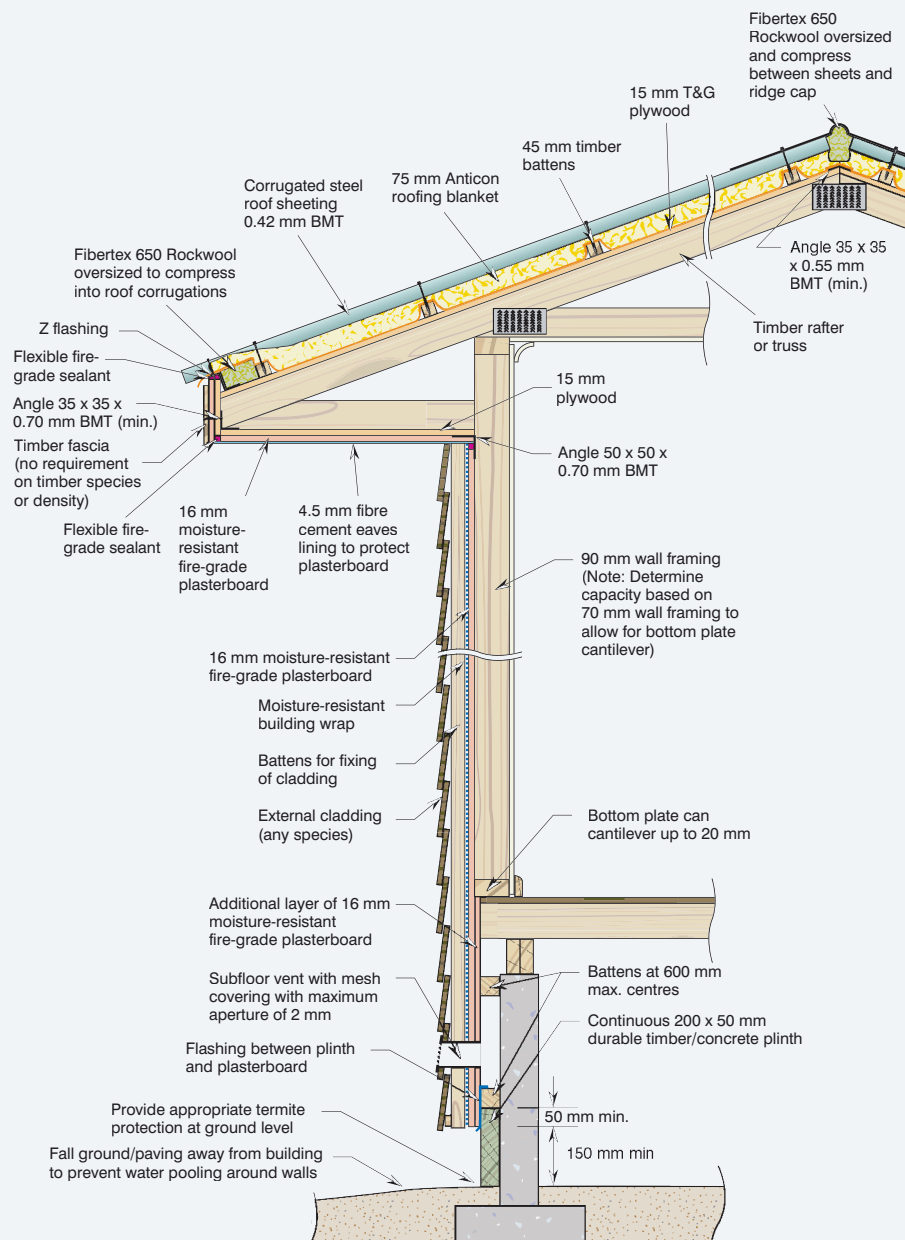

Fire grade plasterboard

For BAL-FZ the Standard, AS 3959-2009 stipulates requirements for external walls. You can use a non-combustible material such as bricks, rock, concrete blocks etc or you can continue to use attractive, space-saving lightweight cladding such as weatherboards and sheeting products such as external grade ply with "A system with an FRL (Fire Resistance Level:) of 30/30/30 or -/30/30 when tested from the outside." (See Section 9 of the Standard).

The Fire Resistance Level (FRL) is the "structural adequacy / integrity / insulation" of the system each measured in minutes.

- Structural adequacy means the ability of a structure to maintain its stability and load-bearing capacity
- Integrity is the ability of a structure to resist the passage of flames and hot gases
- Insulation means the ability of a structure to maintain a temperature below specified limits on the surface *not exposed* to fire.

For example, a FRL requirement for glazing of -/30/- means there is a requirement that the glass can resist the passage of flame and hot gases for at least 30 minutes. The relevant standard is *AS 1530.4-2005 Methods for fire tests on building materials, components and structures – Fire-resistance tests of elements of construction*.

BAL-FZ Diagram 2: Sectional View

Timber and other lightweight cladding Fire-Rated External Wall System using fire-grade plasterboard FRL 60/60/60 Reference: Boral OutRWALL®

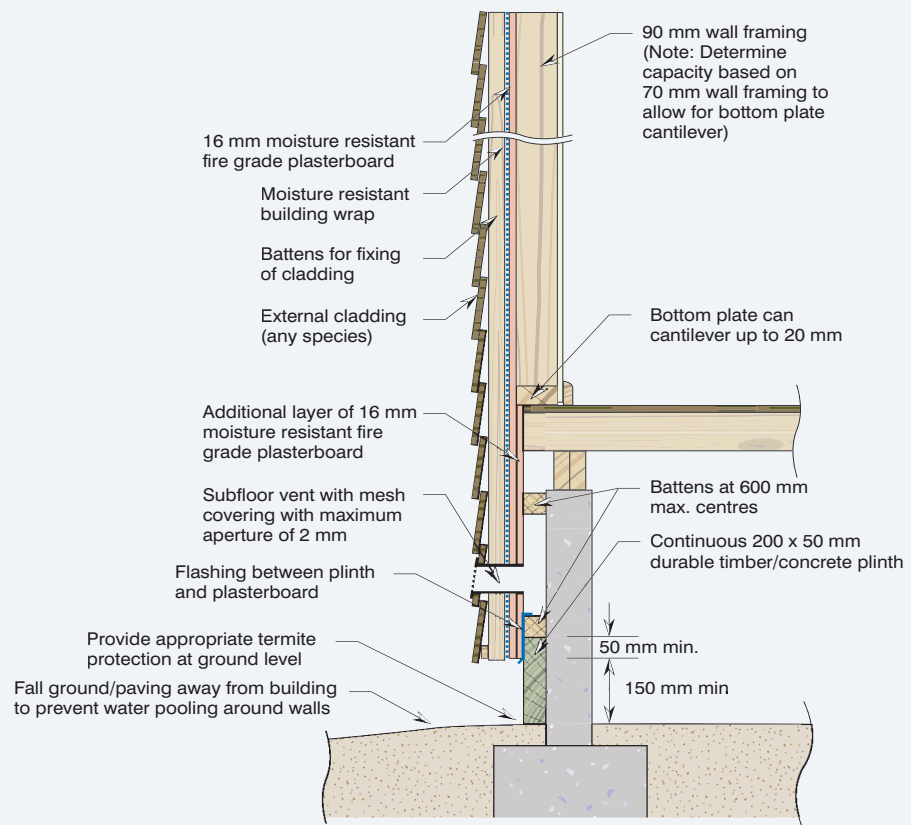

BAL-FZ Diagram 2 shows a sectional view of the Timber and other lightweight cladding Fire-Rated External Wall System using fire-grade plasterboard which achieves double the protection stipulated by the Standard. Key design elements of the system are:

1. Design the wall as a 70 mm timber frame (studs and plates) but utilise 90 mm timber framing. This allows the wall to be cantilevered up to 20 mm at floor level to allow for the additional layer of 16 mm moisture-resistant, fire-grade plasterboard required to enclose the subfloor space.
2. The floor joists supporting the external load-bearing walls are cantilevered to enable the installation of elements within the subfloor space.

3. Install a continuous 200 x 50 mm durable timber (e.g. H4 treated pine) or concrete plinth around the base of the system. This 50 mm thick durable timber is designed to resist burn through for up to 60 minutes and will provide the durability needed at ground level.
4. Install sheets of 16 mm moisture-resistant fire-grade plasterboard to the outside of the wall frame in accordance with the plasterboard manufacturer's requirements for fixings, spacings and joint detailing. Keep the plasterboard at least 150 mm above the ground to minimise possible water penetration.
5. Batten out the wall frame and install your timber cladding of choice over the plasterboard system.
6. Install subfloor vents to provide adequate air movement as required by your local building authority. Screen vents with a mesh made of corrosion resistant steel or bronze that has a maximum aperture of 2 mm.

The preceding assumes a subfloor with concrete or similar piers. This system can also be used in combination with a concrete slab (BAL-FZ Diagram 3) or on base brick work (BAL-FZ Diagram 4).

When used with a concrete slab, leave a gap of 75 mm between the bottom of the cladding and exterior ground surface to minimise possible water penetration.

With base brick work, install required screened subfloor vents and moisture/termite barriers.

As with all buildings, keep garden beds and soil away from the house to enable regular pest or fungal inspections.

BAL-FZ Diagram 3: Sectional view.

Timber and other lightweight cladding Fire-Rated External Wall System using fire grade plasterboard on a concrete slab.

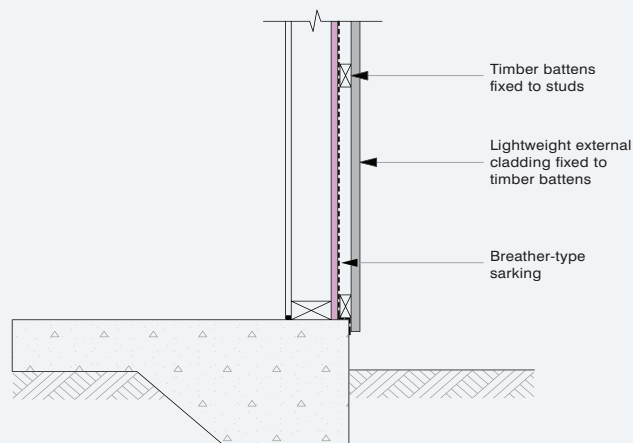

BAL-FZ Diagram 4: Sectional view.

Timber and other lightweight cladding Fire-Rated External Wall System using fire-grade plasterboard with base brick work.

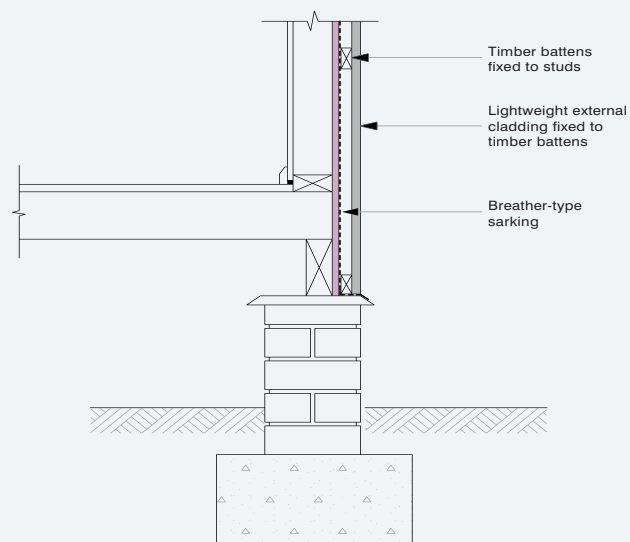

6

Bushfire Flame Zone Resistant Sheet Metal Roofs

The Australian Standard AS 3959-2009 Construction of buildings in bushfire-prone areas (2009) is referenced in the National Construction Code Series Building Code of Australia.

Under the standard, sites that have been assessed at the highest Bushfire Attack Level, Flame Zone (BAL-FZ) must have roof and eaves systems that comply by meeting the requirements of *AS1530 8.2 Test on Elements of Construction for buildings exposed to simulated bushfire attack – large flame source*. This section details the first system for sheet metal roofs to comply and can be found in Appendix I of AS3959-2009. This plywood membrane roof system can be used in combination with any wall cladding system that complies with AS3959-2009 to BAL-FZ, this includes systems utilising wall sheeting and weatherboard.

The roof system uses a membrane of 15 mm plywood over the rafters/trusses with 75 mm Anticon™ Roofing Blanket (glasswool). The eaves system combines 15 mm plywood and 16 mm moisture-resistant fire grade plasterboard.

As additional roof solutions are tested and certified for compliance with BAL-FZ, up-to-date information can be found at www.woodsolutions.com.au as it becomes available.

The AS1530 8.2 test method is quite severe. The resultant building systems resemble the fire-rated requirements commonly used for wall or floor construction. Roofing installers must ensure the same level of care and supervision applies when building bushfire resisting roofs and eaves systems.

The prevention of embers, radiant heat and flames through the roof system is critical. The following details are important for the points that are known to be most vulnerable, e.g. the leading edge of roofing (at fascias, ridge, hips and valleys). Obviously, by simplifying the roof design you can reduce the opportunity for the fire to breach the roof system and gathering points for embers. You will also save on construction and material costs.

Plywood Membrane Roof System for BAL-FZ

Plywood sheeting between the roof cavity and insulation system provides a rigid base for the mineral wool and is a material that will smoulder rather than melt and collapse in extreme conditions.

To meet the test Standard:

- 15 mm tongue and grooved (T&G) plywood is placed directly over the rafters/trusses, with the face veneer at right angles to the rafter direction.
- The end joints must be made over rafter edges.
- Where a free end is unavoidable, use a nogging (not less than 70 mm x 35 mm) running between the rafters and set flush to the top of the rafters.
- Each plywood panel must be continuous over more than one span.

Readily available plywood stress grades are F11 and F14.

Diagram 1 shows the AS3959-2009 BAL-FZ compliant roof system using a plywood membrane.

Diagram 1: Plywood roof system

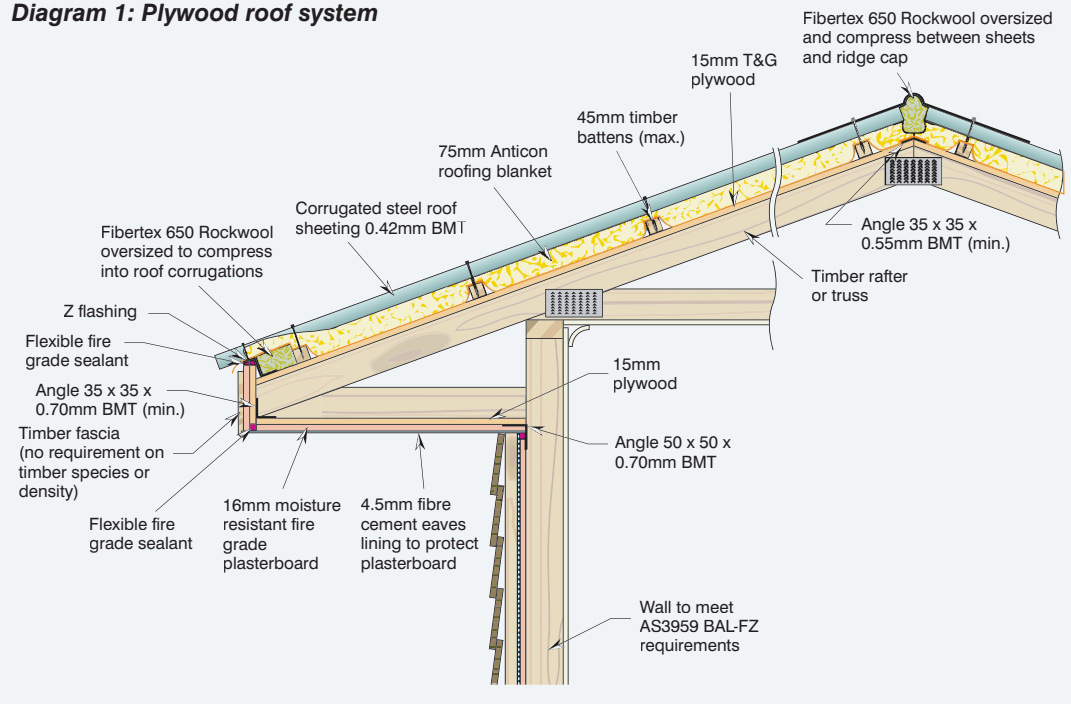

Fixing Plywood

To fix the plywood to the rafters/trusses, use the same method as for fixing plywood flooring, (detailed in AS1684 *Residential timber-framed construction* standards).

Space nails and/or screws at 150 mm centres at panel ends and at 300 mm centres at intermediate rafters/trusses and noggings. Do not fix the plywood at less than 10 mm from edges.

Hand driven nails	2.8 mm minimum diameter, flathead or bullet head nail, minimum length of 40 mm (this length is 2.5 times plywood thickness)
Gun driven nails	2.5 mm minimum diameter gun nails, minimum length of 40 mm (this length is 2.5 times the plywood thickness)
Screws to timber joists	No. 8 x 30 self-drilled countersunk wood screws.

At the ridge and valley position, the plywood joint must be covered by a 35 x 35 mm x 0.55BMT (BMT = base metal thickness) angle or flashing.

Battens

Use timber battens with a maximum size of 45 mm x 90 mm. Traditional timber battens are 35-38 mm thick and therefore comply. They are also easy to handle and fix.

When fixing battens to rafters/trusses roofing installers need to comply with the specific tie-down as required for the site's location.

Insulation

Roof systems for BAL-FZ require additional steps and materials compared to traditional steel roofs. The steps described below detail how to provide protection to the points known to be most vulnerable. e.g. the leading edge of roofing (at fascias, ridge, hips and valleys). These steps are vital to ensure that the roofing system performs as tested, to limit the possibility of entry of embers, radiant heat and flames.

Roof area

To comply with the tested system, lay 75 mm Anticon™ Roofing Blanket over the roof filling the void between the plywood deck and the underside of the metal sheet.

Interface with fascia

At the interface of the metal roof sheet and the fascia, use an oversized Fibretex 650 Rockwool strip to seal between the plywood and the roof sheet. The Rockwool strip is to be 75 mm thick by 90 mm high, fitted snugly between the Z flashing and the first lower roof batten and placed continuously along the roof's edge (see Diagram 2). The Anticon™ Roofing Blanket (foil facing down) is laid over the battens and the Rockwool strip and under the roof sheeting. Compress the blanket, along with the Rockwool, to assist in sealing off the leading edge of the roof sheeting.

Roof ridge and hips

At the ridge and hips, install a 90 mm high by 75 mm thick strip of Fibretex 650 Rockwool fitted between the ends of the roof sheets so that the Rockwool is compressed to 50 per cent of its thickness and placed above the Anticon™ Roofing Blanket.

Valleys

On both sides of the valley, install two layers of 15 mm plywood 'strips' on top of the plywood membrane cut to neatly fit under the valley gutter.

At the interface of the metal roof sheet and the valley, use an oversized Fibretex 650 Rockwool strip to seal between the plywood and the roof sheet. The Rockwool strip is to be 75 mm thick by 90 mm high, fitted snugly between the Z flashing and the first lower roof batten and placed continuously along both valley edges – detail similar to Diagram 2. Between the Z flashing and the double plywood strips, apply fire grade sealant along each side of the valley.

The Anticon™ Roofing Blanket (foil facing down) will cover the Rockwool strip but needs to be trimmed back to the Z flashing to avoid moisture problems. Compress the blanket, along with the Rockwool, to assist in sealing off the leading edge of the roof sheeting.

Roof Sheeting

To reach AS1530 8.2 *Test on Elements of Construction for buildings exposed to simulated bushfire attack – large flame source*, use 0.42 mm BMT corrugated roof sheets that comply with AS1445. Fix the roof sheets normally, except you need to apply double fixings along the leading edge of the roof into the Z flashing (see detail plan view, Diagram 3).

Eaves, Fascia And Barge Boards

Testing revealed that eaves and fascia construction does not benefit from the inclusion of insulation, so the system requires a different approach.

The BAL-FZ sheet metal roof system solution for fascia and eaves takes advantage of the strength of plywood in both the eaves soffit and fascia to achieve fire resistance. It combines 15 mm plywood and 16 mm fire-grade moisture-resistant plasterboard to effectively seal the building envelope at these points.

First fix the plywood sheet to the framing (using the same methods described for the roof).

Over the plywood, fix 16 mm fire grade moisture-resistant plasterboard to the timber framing using 38 mm x 6 g needlepoint screws at 150 mm centres – plasterboard oriented so that butt joints do not fall on joints in plywood.

Diagram 2: Eaves, Fascia and Bargeboard details for compliant sheet metal roof systems.

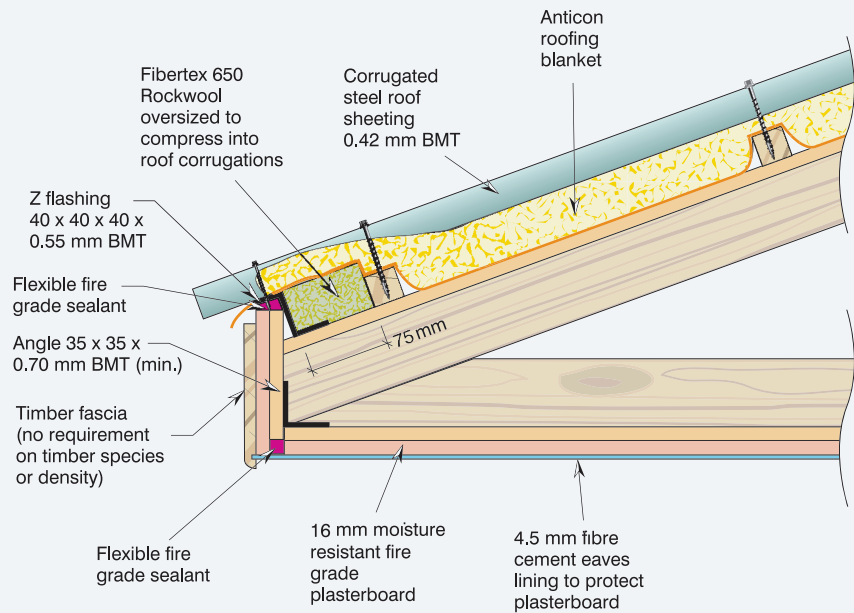
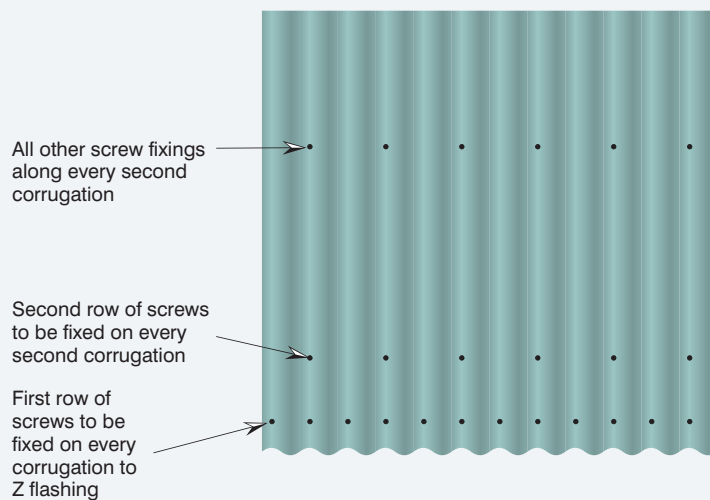

Diagram 3: Detail, Roof fixing requirements



Joists, corners and abutting sections

Use flexible fire-grade mastic to seal joints in the 16 mm fire-grade moisture-resistant plasterboard, corners or where the plasterboard abuts another element.

Support the plasterboard by using 35 x 35 x 0.70 mm angles, timber noggings or follow the plasterboard manufacturer's requirements.

Weather protection

Cover the 16 mm fire-grade moisture-resistant plasterboard with a weather protector. For the:

- Eaves soffit – 4.5 mm (minimum) fibre cement eaves lining.
- Fascias or bargeboards – standard 19 mm timber fascia.

These elements are an integral part of the roof system.

Other issues

This data sheet details the roof system requirements to meet the fire resistance mandated by the test method.

This data sheet does not address other issues, such as durability, ventilation, structural adequacy, bracing, fixing (unless required by the fire test) or tie-down that may affect the roof. Designers and/or roofing installers should seek information on these matters from relevant technical sources.

Using materials of other thicknesses or densities

Information contained in this data sheet represents the minimum to meet the tested system. Products that are thicker or denser maybe used, unless otherwise indicated herein.

Proprietary products

Products that are described by manufacturer's name (eg Anticon™) cannot be substituted for similar products.

Compliance information

This section outlines how to comply with BAL-FZ with a sheet metal roof. It outlines the requirements as described in AS3959-2009 *Construction of buildings in bushfire-prone areas* Standard. The system described above complies with AS1530.8.2 *Methods for fire tests on building materials, components and structures*. The report on which this is based is:

Exova Warringtonfire Report No: RIR 23626A-07 – An assessment of the bushfire attack level (BAL) performance of various sheet metal roof systems if tested in accordance with AS1530.8.2-2007 Section 16 (Flame Zone).

Wall cladding systems and other exterior construction elements

The roof system can be used in combination with any wall cladding system that complies with AS3959-2009 to the relevant bushfire attack level. A system combining traditional light-weight cladding materials (including weatherboard and fibre cement sheeting) and a moisture-resistant, fire-grade plasterboard can achieve a Fire Resistance Level (FRL) in excess of the Standard requirements at BAL-FZ (FRL 30/30/30). Find out more from your specialist plasterboard supplier.

Ensure that alternative exterior wall sections used in combination with, or to replace, brick veneer comply with the relevant requirements in the Standard.

A

Appendix A - NSW variations to building requirements

Simplified Bushfire Standard Complying Timber Construction in NSW

The NSW building regulations vary the requirements in the Acceptable Construction Manual within the Building Code of Australia (BCA) for construction in Bushfire-prone Areas.

To help understand the differences between construction to the AS3959 *Construction of buildings in bushfire-prone areas* standard, as spelt out in WoodSolutions Technical Design Guide 04 *Building with Timber in Bushfire prone Areas* and Planning for Bushfire Protection - Addendum: Appendix 3, NSW Rural Fire Service - Planning for Bush Fire 'Protection' the following table incorporates the requirements of both guides.

Although every effort has been taken to reflect the requirements contained in the NSW Rural Fire Service - Planning for Bush Fire Protection and AS 3959 *Construction of buildings in bushfire-prone areas* standard, it is recommended that this information sheet be used in conjunction with these two documents, especially where in doubt.

Reading the Tables

Information provided within the following table relates to the minimum allowable construction requirements for timber and wood products. There are many other non-timber systems that can be used and are described in this Guide or AS3959. Solutions described in a higher BAL level can also be used in lower BAL levels. For simplicity the higher performing solutions are not repeated in the lower BAL levels.

For construction solutions in BAL-40 and FZ the NSW Rural Fire Service also consider that due regard be given to the psychological impact that flaming of external walls could have on building occupants.

Building element	BAL-12.5 and BAL-19	BAL-29	BAL-40	BAL-FZ
Building subfloor space – enclosed				
Wall enclosing subfloor space	Less than 400 mm from the ground or an external horizontal surface ¹ use timber framing provided the framing is clad with non-combustible material such as fibre cement or timber with density of 750 kg/m ³ or greater. 400 mm or more above the ground ¹ there are no construction requirements any timber framing or cladding can be used.	All timber framing provided the framing is clad with non-combustible sheet material (6 mm fibre cement) or bushfire-resisting timber. ²	All timber provided the framing is clad with masonry, steel material or min 9 mm fibre cement.	NSW building regulations do not recognise deemed-to-satisfy construction solutions within this BAL. Building designs will require an Alternative Solution.
Posts, stumps, columns, etc	All durable timber species and suitable preservative treated timber as usual.			
Floor bearers and joists	All timber species and engineered timber products as usual.			
Flooring	All timber T & G, plywood and particleboard products as usual.			
Building subfloor space - open				
Posts, stumps, columns, etc	Bushfire-resisting timber ²		Brick, steel or concrete stumps	NSW building regulations do not recognise deemed-to-satisfy construction solutions within this BAL. Building designs will require an Alternative Solution.
Floor bearers and joists	Less than 400 mm above the ground use bushfire-resisting timbers ² or line the underside of the floor framing with fibre cement or sheet metal (roofing), refer Figure 2. 400 mm or more above the ground there are no construction requirement any timber can be used. ⁴	All timber framing provided the underside of the lowest joist or bearer is protected with a non-combustible material such as a metal roof sheet or fibre cement sheeting.		
Flooring	Less than 400 mm from the ground provided the underside is lined with sarking or mineral wool or bushfire-resisting timbers ² all timber T & G, plywood and particleboard products as usual. 400 mm or more above the ground there are no construction requirement any timber timber T & G, plywood and particleboard products as usual.	All timber species provided the underside of the lowest joist or bearer is protected with a non-combustible material such as a metal roof sheet or fibre cement sheeting, all timber T & G, plywood and particleboard products as usual.		
Internal framing	All timber species and engineered timber products as usual.			
Internal joinery	Including doors, wall lining, ceiling linings, staircases, etc, all timber as usual.			
Fascia and barge boards	All durable timber species and suitable preservative treated timber as usual.	Bushfire-resisting timber ²	AS1530 8.1 complying system	
Eaves linings and gables including joining strips	All durable timber species and suitable preservative treated timber as usual.	Bushfire-resisting timber ²	AS1530 8.1 complying system	
Tile roof	Framing – all timber species and engineered timber framing members as usual.			
Sheet roof	Framing – all timber species and engineered timber framing members as usual.			
External windows				
Protected window frames (fitted with screen or shutter, refer to AS3959 for shutter and screen requirements for each BAL Level)	All durable timber species and suitable preservative treated timber as usual.			NSW building regulations do not recognise deemed-to-satisfy construction solutions within this BAL. Building designs will require an Alternative Solution.
Unprotected window frames	400 mm or more above an external horizontal surface ¹ all durable timber species and suitable preservative treated timber as usual. Closer than 400 mm to an external horizontal surface ¹ timber species with density 650 kg/m ³ or greater. ⁴	Bushfire-resisting timber ²	AS1530 8.1 complying system	

Building element	BAL-12.5 and BAL-19	BAL-29	BAL-40	BAL-FZ
External walls				
Framing for all wall surfaces	All structural timber and engineered wood products, as usual.			NSW building regulations do not recognise deemed-to-satisfy construction solutions within this BAL. Building designs will require an Alternative Solution.
Wall surface less than 400 mm above the ground or an external horizontal surface ²	Weatherboard plywood, hardboard with density of 750 kg/m ³ or greater ⁴ and log construction with density of 680 kg/m ³ or greater and minimum thickness of 70 mm.	Bushfire-resisting timber ² and log construction with density of 680 kg/m ³ or greater and minimum thickness of 70 mm.	Wall surface made of non-combustible material such as masonry, concrete, 9 mm fibre cement or steel sheeting. No limits on frame material.	
Wall surface 400 mm or more above the ground or an external horizontal surface ²	All durable timber species and suitable preservative treated timber as usual.			
External door				
Protected door (fitted with screen or shutter and refer to AS3959 for shutter and screen requirements for each BAL Level)	All timber species as usual.			NSW building regulations do not recognise deemed-to-satisfy construction solutions within this BAL. Building designs will require an Alternative Solution.
Unprotected door	All timber species provided the first 400 mm above the threshold is a minimum of 35 mm thick or protected by 400 mm kick plate. Alternatively the entire door is made from a timber species with density 650 kg/m ³ or greater. ⁴ .	All timber species provided it is a minimum of 35 mm thick. Alternatively the entire door is made from bushfire-resisting timber. ²	AS1530 8.1 complying system.	
Stairs/decks/ramps – enclosed sub-structure				
Wall enclosing subfloor space	Less than 400 mm from the ground or an external horizontal surface ¹ use timber framing provided the framing is clad with non-combustible material such as fibre cement or timber with density of 750 kg/m ³ or greater. 400 mm or more above the ground ¹ there are no construction requirement any timber framing or cladding can be used.	All timber framing provided the framing is clad with non-combustible sheet material (6 mm fibre cement) or bushfire-resisting timber. ²	All Timber framing provided the framing is clad with masonry, steel material or min 9 mm fibre cement.	NSW building regulations do not recognise deemed-to-satisfy construction solutions within this BAL. Building designs will require an Alternative Solution.
Posts, stumps, columns, etc	All durable timber species and suitable preservative treated timber as usual.			
Floor bearers and joists	All timber species and suitable preservative treated timber as usual.			
Decking and stair treads	Bushfire-resisting timber ² . Limited up to and including BAL-29.	Tiled or concrete decks		
Stairs/decks/ramps – open sub-structure				
Posts, stumps, columns, etc	Bushfire-resisting timber ²		Metal, concrete or brick	NSW building regulations do not recognise deemed-to-satisfy construction solutions within this BAL. Building designs will require an Alternative Solution.
Floor bearers and joists	Bushfire-resisting timber ²		Metal	
Decking and Stair treads	Bushfire-resisting timber ²		Tiled or concrete decks	

Building element	BAL-12.5 and BAL-19	BAL-29	BAL-40	BAL-FZ
Stairs/decks/ramps – open sub-structure				
Posts, stumps, columns, etc	Bushfire-resisting timber ²		Metal, concrete or brick	NSW building regulations do not recognise deemed-to-satisfy construction solutions within this BAL. Building designs will require an Alternative Solution.
Floor bearers and joists	Bushfire-resisting timber ²		Metal	
Decking and stair treads	Bushfire-resisting timber ²		Tiled or concrete decks	
Balustrades and handrails				
	Less than 125 mm from any glazing or any combustible wall handrails and balustrades shall made from non combustible material or bushfire-resisting timber. ² 125 mm or more from the building handrails and balustrades have no requirement any timber can be used. ⁴			NSW building regulations do not recognise deemed-to-satisfy construction solutions within this BAL. Building designs will require an Alternative Solution.

Notes:

1. An external horizontal surface or a ledge includes decks, carport roofs, awnings and similar elements or fittings having an angle less than 18 degrees to the horizontal and extending more than 110 mm in width from the wall or window or door. **See diagram below**

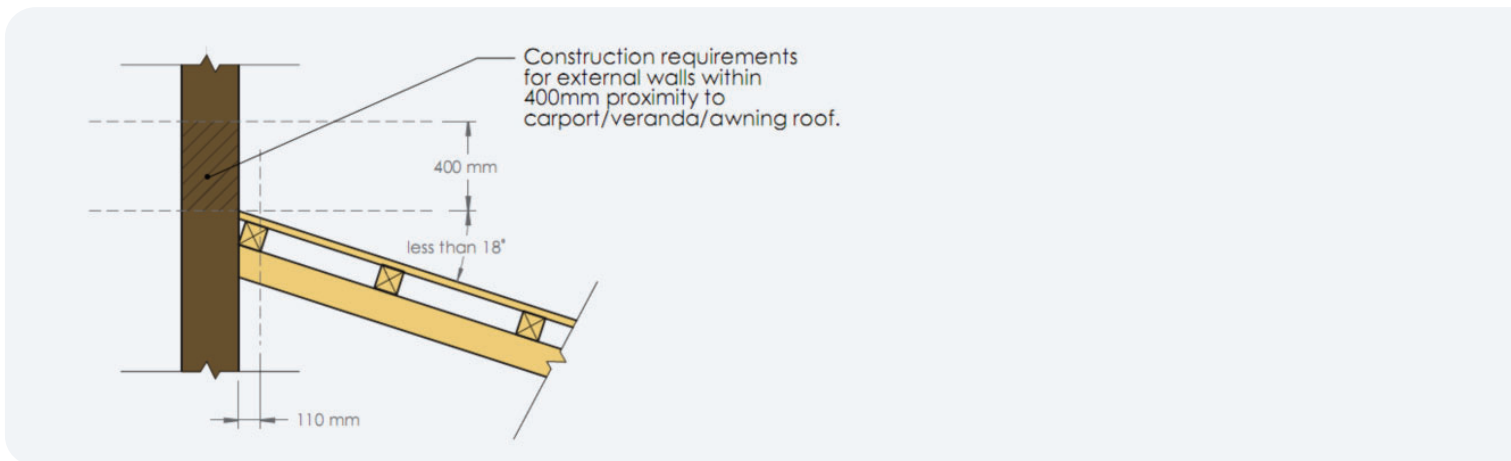

- 2. Bushfire resisting timbers refer WoodSolutions Guide 04 Section 4.
- 3. Complying roof systems include conventional non combustible roof and materials (tile, metal sheet) ensuring any gaps over 3mm are protected by ember guards. For further detail on sealants, skylights, etc refer to AS 3959.
- 4. Timber with density of 750 kg/m³ or greater at 12 percent moisture content.
- 5. Timber with density of 650 kg/m³ or greater at 12 percent moisture content.
- 6 Wood Solutions Guide 04: Building with Timber in Bushfire prone Areas is available for free on www.woodsolutions.com.au

Disclaimer:

Whilst every effort has been made to ensure that this publication is in accordance with current information, it is not intended as an exhaustive statement of all relevant data. All comments in this information sheet are written with timber framed construction in mind and may exclude other forms of construction. In addition, successful design and construction depends upon numerous factors outside the scope of this publication. The authors and publishers accept no responsibility for errors in, or omissions from this publication, nor for specifications or work done or omitted in reliance on this publication.

B

Appendix B - South Australian variations to building requirements

Bushfire Complying Timber Construction in South Australia

South Australian building regulations have their own construction requirements for building in bushfire-prone areas. The regulations are a mixture of requirements from AS 3959 *Construction of buildings in bushfire-prone areas* and their own additional requirements - the following table incorporates both.

Although every effort was taken to reflect regulations of AS 3959 *Construction of Buildings in Bushfire-prone Areas* standard and the BCA's South Australian variation, it is recommended this information sheet be used in conjunction with AS 3959 and the BCA; especially where in doubt.

Bushfire Attract Levels South Australia Only

The South Australia Development Plan identifies areas of bushfire risk and nominates the Bushfire Attack Level that must be applied to construction within these areas. These areas are;

- General Bushfire Risk *requiring* BAL-LOW construction,
- Medium Bushfire Risk *requiring* BAL-12.5 construction, and
- High Bushfire Risk to be assessed and constructed in accordance with AS3959.

As well, construction within *excluded areas* are to be constructed to BAL-LOW requirements if it is within 500 m of High Bushfire Risk areas. Excluded areas are defined by South Australian Development Plan and are existing townships and other settlements that have an adequate water supply for fighting fires and suitable emergency vehicle access. For excluded vegetation areas within 100 m of High Bushfire Risk areas, the bushfire attack level is to be assessed in accordance with AS3959.

Reading the Tables

Information provided within the following table relates to the minimum allowable construction requirements for timber and wood products. There are many other non-timber systems that can be used and are described in WoodSolutions Guide 04 or AS3959. Solutions described in a higher BAL level can also be used in lower BAL levels. For simplicity the higher performing solutions are not repeated in the lower BAL levels.

Building element	BAL-LOW	BAL-12.5	BAL-19	BAL-29	BAL-40	BAL-FZ
Building subfloor space – enclosed						
Wall enclosing subfloor space	All timber framing provided the framing is clad with non-combustible sheet material (fibre cement 6 mm minimum) or bushfire-resisting timber. ¹		All timber framing provided the framing is clad with non-combustible sheet material (fibre cement 6 mm minimum) or bushfire-resisting timber. ¹		All timber framing provided the framing is clad with non-combustible clad, i.e. masonry or min 9 mm fibre cement.	All timber framing provided the framing is clad with non-combustible clad, (e.g. masonry, brick veneer, concrete etc) with a min of 90 mm thickness.
Post stumps, columns, etc	All durable timber species and suitable preservative treated timber as usual					
Floor bearers and joists	All timber species and engineered timber products as usual					
Flooring	All timber T & G, plywood and particleboard products as usual					
Building subfloor space – Open						
Post stumps, columns, etc	Bushfire-resisting timber ¹ for the first 400 mm from the ground or any durable timber species mounted on metal stirrups with a clearance of not less than 75 mm above finished ground level.		Bushfire-resisting timber ¹		Brick, steel or concrete stumps	
Floor bearers and joists and flooring	Less than 600 mm above ground in which case bushfire-resisting timber ¹ must be used. 600 mm or more above the ground all timber species and engineered timber products can be used.		Less than 600 mm above ground in which case bushfire-resisting timber ¹ must be used. 600 mm or more above the ground all timber species and engineered timber products can be used.		All timber species and engineered timber products provided the underside of the lowest joist or bearer is protected with a non-combustible material such as a metal roof sheet or fibre cement sheeting.	All timber species and engineered timber products provided floor system has FRL 30/30/30 with non-combustible surface material.
Internal framing	All timber species and engineered timber products as usual.					
Internal joinery	Including doors, wall lining, ceiling linings, staircases, etc – all timber as usual.					
Fascia and barge boards	All durable timber species and suitable preservative treated timber as usual.		Bushfire-resisting timber ¹		Non-combustible but not fibre cement	Any timber ⁴ provided it is part of a roof system as outlined in Wood Solutions Guide 04 ⁵
Eaves linings and gables including joining strips	All durable timber species and suitable preservative treated timber as usual.		Bushfire-resisting timber ¹		Non-combustible	Fibre cement as part of a roof system as outlined in Wood Solutions Guide 04 ⁵
Tile roof	Framing – all timber species and engineered timber framing members as usual.					Any timber provided framing is part of a roof system as outlined in Wood Solutions Guide 04 ⁵
Sheet roof	Framing – all timber species and engineered timber framing members as usual.					Any timber provided framing is part of a roof system as outlined in Wood Solutions Guide 04 ⁵

Building element	BAL-LOW	BAL-12.5	BAL-19	BAL-29	BAL-40	BAL-FZ
External windows						
Protected window frames (fitted with screen or shutter, refer to AS3959 for shutter and screen requirements for each BAL Level)	All durable timber species and suitable preservative treated timber as usual.					
Unprotected windows frames	All durable timber species and suitable preservative treated timber as usual.	400 mm or more above an external horizontal surface ² All durable timber species and suitable preservative treated timber as usual. Closer than 400 mm to an external horizontal surface ² timber species with density 650 kg/m ³ or greater.	Bushfire-resisting timber ¹	Bushfire-resisting timber ¹	AS1530 8.1 complying system	AS1530 8.2 complying system
External walls						
Framing for all wall surfaces	All structural timber and engineered wood products, as usual.					
Wall surface less than 400 mm above the ground or an external horizontal surface ²	All durable timber species and suitable preservative treated timber as usual.	Weatherboard plywood, hardboard with density of 750 kg/m ³ or greater ³ and log construction with density of 680 kg/m ³ or greater and minimum thickness of 70 mm.	Bushfire-resisting timber ¹ and log construction with density of 680 kg/m ³ or greater and minimum thickness of 70 mm.	Wall surface made of non combustible material such as masonry, concrete, 9 mm fibre cement or steel sheeting. No limits on frame material.	Wall surface made of non combustible material a min of 90 mm thickness (e.g. masonry, brick veneer, concrete etc). No limits on frame material.	
Wall surface 400 mm or more above the ground or an external horizontal surface ²	All durable timber species and suitable preservative treated timber as usual.	All durable timber species and suitable preservative treated timber as usual.				
External doors						
Protected Door (fitted with screen or shutter and refer to AS3959 for shutter and screen requirements for each BAL Level)	All timber species as usual.	All timber species as usual and screens cannot be made from aluminium.	All timber species as usual, and screens cannot be made from aluminium and shutters must be made from non-combustible materials.	All timber species as usual, and screens cannot be made from aluminium and shutters must be made from non-combustible materials.	All timber species as usual and shutter must comply with AS1530 8.2.	
Unprotected door	All timber species as usual.	All timber species as long as the first 400 mm above the threshold is a minimum of 35 mm thick or protected by 400 mm kick plate. Alternatively the entire door is made from a timber species with density 650 kg/m ³ or greater.	All timber species provided it is a minimum of 35 mm thick Alternatively the entire door is made from bushfire-resisting timber. ¹	AS1530 8.1 complying system	AS1530 8.2 complying system	

Building Element	BAL-LOW	BAL-12.5	BAL-19	BAL-29	BAL-40	BAL-FZ
Open Verandah, deck, steps, ramps and landing (excludes T&G and sheeted flooring) - Enclosed						
Not allowed						
Open Verandah, deck, steps, ramps and landing (excludes T&G and sheeted flooring) - Open						
Subfloor supports (posts, stumps, columns, stair stringers etc)	Less than 600 mm above ground in which case bushfire-resisting timber ¹ or any durable timber species and suitable preservative treated timber as mounted on metal stirrups with a clearance of not less than 75 mm above ground. 600 mm or more above ground durable timber species and suitable preservative treated timber as usual.			Bushfire-resisting timber ¹	Brick, steel or concrete stumps.	
Bearers and joists	Any durable timber species and suitable preservative treated timber as usual.			Bushfire-resisting timber ¹	Metal	
Decking⁶ and stair treads	Any durable timber species and suitable preservative treated timber with the gap between the timber deck flooring not less than 5 mm and the timber decking separated from the remainder of the building in a manner that will not spread the fire into the building.	Bushfire-resisting timber ¹ with the gap between the timber deck flooring not less than 5 mm and the timber decking separated from the remainder of the building in a manner that will not spread the fire into the building.		Tiled or concrete decks.		
Balustrades and handrails	Less than 125 mm from any glazing or any combustible wall handrails and balustrades shall be made from non-combustible material. 125 mm or more from the building handrails and balustrades have no requirement.			Must be non combustible or bushfire-resisting timber ¹ must be used.		Must be non combustible.

Notes:

1. Bushfire resisting timbers refer WoodSolutions Guide 04, Section 4.
2. An external horizontal surface or a ledge includes decks, carport roofs, awnings and similar elements or fittings having an angle less than 18 degrees to the horizontal and extending more than 110 mm in width from the wall or window or door. **See diagram below**

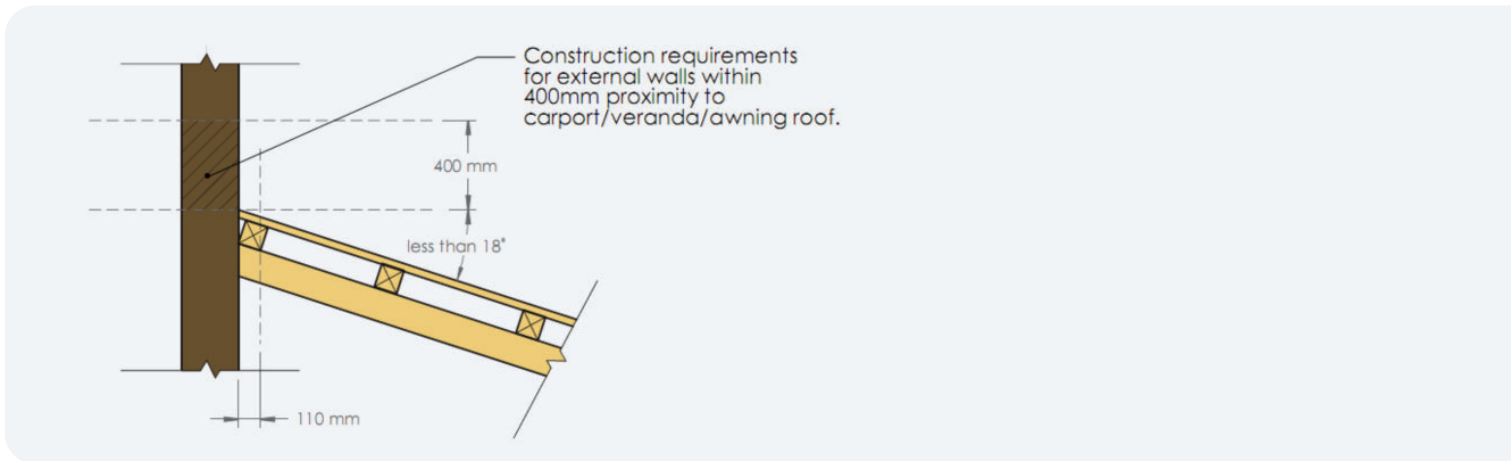

3. Timber with density of 750 kg/m³ or greater at 12 percent moisture content.
4. Complying roof systems include conventional non combustible roof and materials (tile, metal sheet) ensuring any gaps over 3 mm are protected by ember guards. For further detail on sealants, skylights, etc refer to AS 3959.
5. WoodSolutions Guide 04: Building with Timber in Bushfire prone Areas is available for free on www.woodsolutions.com.au
6. Refer additional requirements for decking within 300 mm of glazed elements for the relevant BAL.

Disclaimer:

Whilst every effort has been made to ensure that this publication is in accordance with current information, it is not intended as an exhaustive statement of all relevant data. All comments in this information sheet are written with timber framed construction in mind and may exclude other forms of construction. In addition, successful design and construction depends upon numerous factors outside the scope of this publication. The authors and publishers accept no responsibility for errors in, or omissions from this publication, nor for specifications or work done or omitted in reliance on this publication.

Design tips to reduce risk

✓Design with a simple footprint

Minimise external nooks and crannies, corners and spaces where debris (which can become fuel) or embers from a bushfire can accumulate.

✓Use a simple roof design

Avoid roof valleys and skylights. Specify and install gutter guards to help keep the gutters clear and free of debris.

✓Raise window level

Lift windows from floor level to at least 400 mm above an external surface which may collect smouldering embers or burning debris - this simplifies building requirements (up to BAL-29), without sacrificing views.

✓Enclose the subfloor area

Reduce the risk of embers getting underneath a house by ensuring it is fully enclosed below the floor level and fitting vents with spark-proof metal screens.

✓Use appropriate cladding material

Where cladding materials are mixed - each section must comply with the Standard requirements for external walls. Lightweight cladding (weatherboard, ply or fibre cement sheet) building systems are described on pages 32 and 33.

✓Create a firebreak around the house

Leave a firebreak between nearby vegetation and the house. This is an important part of garden design and can be as simple as having a pathway or lawn between the house perimeter and the nearest garden bed.

✓Use appropriate timber for external detailing

Consider sourcing external decorative details such as finials and verandah brackets and slats from bushfire-resisting timbers or from E1 timbers.

✓Do not ignore the risk of an ordinary domestic fire starting inside

Ensure adequate smoke alarms are installed and homeowners can reach them safely for testing and replacing batteries. What avenues for egress are there in case of fire? Are these adequate or does the design need to be modified? You may need to balance requirements such as protective screens over opening windows with a removal system that will permit using the window as an escape route from fire or other danger. Review the placement of external doors to enable escape from more than one direction.



Discover more ways to build your knowledge of wood

If you need technical information or inspiration on designing and building with wood, you'll find WoodSolutions has the answers. From technical design and engineering advice to inspiring projects and CPD linked activities, WoodSolutions has a wide range of resources and professional seminars.

www.woodsolutions.com.au

Your central resource for news about all WoodSolutions activities and access to more than three thousand pages of online information and downloadable publications.

Technical Publications

A suite of informative, technical and training guides and handbooks that support the use of wood in residential and commercial buildings.

WoodSolutions Tutorials

A range of practical and inspirational topics to educate and inform design and construction professionals. These free, CPD related, presentations can be delivered at your workplace at a time that suits you.

Seminars and Events

From one day seminars featuring presentations from leading international and Australian speakers to international tours of landmark wood projects, WoodSolutions offer a range of professional development activities.

What is WoodSolutions?

Developed by the Australian forest and wood products industry for design and building professionals, WoodSolutions is a non-proprietary source of information from industry bodies, manufacturers and suppliers.